

**SYNEGO**<sup>®</sup>  
TECHNICAL INFORMATION  
PROFILE PRINT



# SYNEGO®

## PROFILE PRINT

### Table of contents

Frame AD . . . . .	2
Mullion-Transom AD . . . . .	6
Frame MD . . . . .	8
Mullion-Transom MD . . . . .	17
Compensating profile . . . . .	19
Sash . . . . .	23
Sash muntins . . . . .	30
Profiles for multi-sash windows without fixed mullions . . . . .	32
Accessories for mechanical connectors . . . . .	38
Threshold and accessories . . . . .	43
Outward opening element accessories . . . . .	48
Accessories for glass bonding sash . . . . .	48
Accessories for entry and side doors . . . . .	49
Drilling jig . . . . .	50
Reinforcements . . . . .	52
Article directory . . . . .	63
Legend . . . . .	68
Variant system . . . . .	69







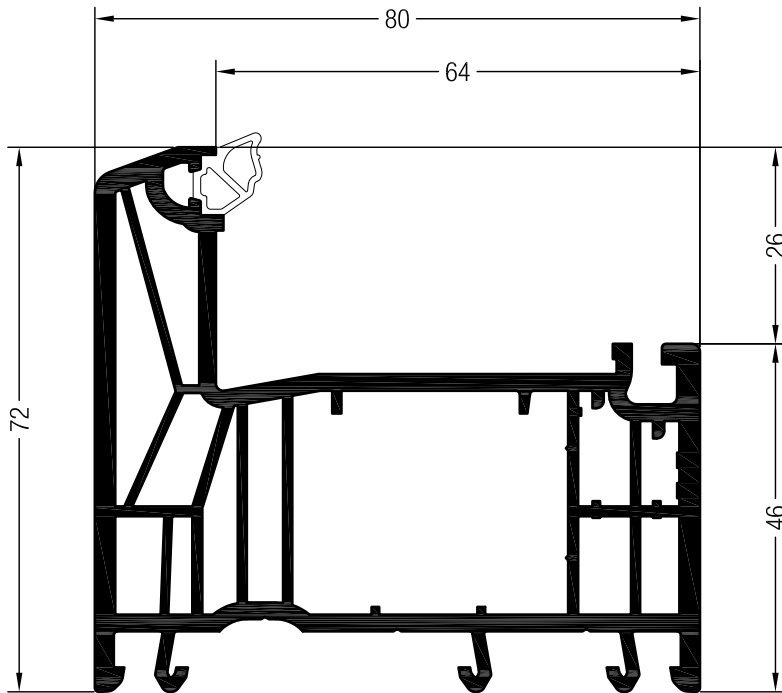





# SYNEGO®

## PROFILE PRINT





### Frame AD



Frame 72 AD PULS SYNEGO®

- 1537005   
-   
- 1567005   
-    @

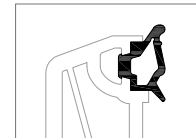

Frame 72 AD PULS SYNEGO®  
for aluminium cover profiles

- 1537008   
-  24



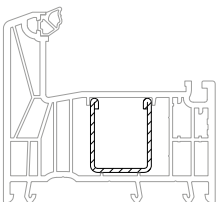

23 x 28



	<b>1306619</b>
	1.5
lx	1.1
ly	1.1
	6

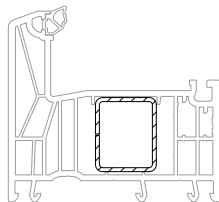

23 x 28



	<b>1357540</b>
	1.5
lx	1.1
ly	1.5
	6

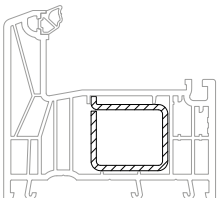

29 x 28



	<b>1357550</b>
	2
lx	2.3
ly	1.8
	6

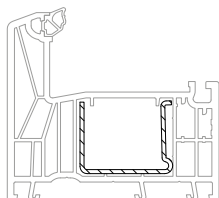

35 x 28



	<b>1244506</b>
	1.5
lx	2.5
ly	1.1
	6

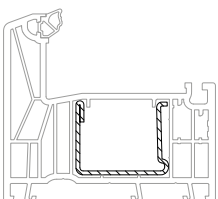

35 x 28

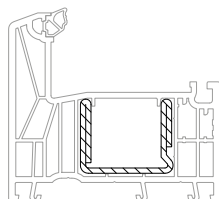

	<b>1244516</b>	<b>1244526</b>
	1.5	2
lx	2.7	3.5
ly	1.3	1.7
	6	6

35 x 28



	<b>1244536</b>
	2
lx	5
ly	2
	6

# SYNEGO®

## PROFILE PRINT

### Frame AD

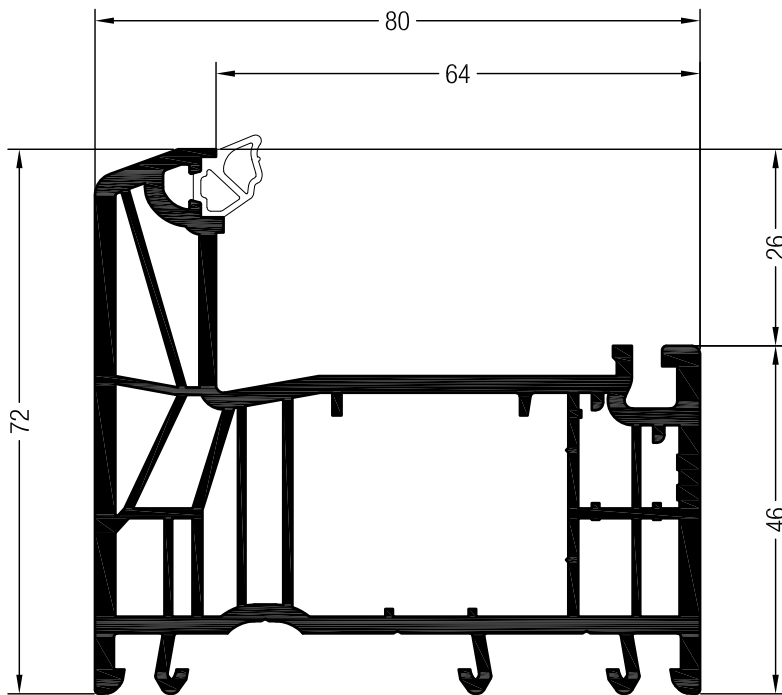

Frame 72 AD PULS SYNEGO®

1537605

1567605

@

24

Frame 72 AD PULS SYNEGO®  
for aluminium cover profiles

1537608

24

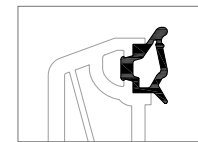

Supply availability as of 05.2018.

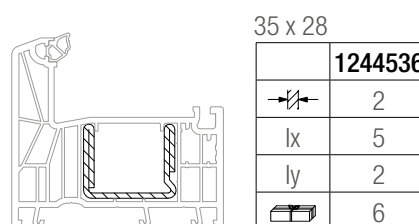
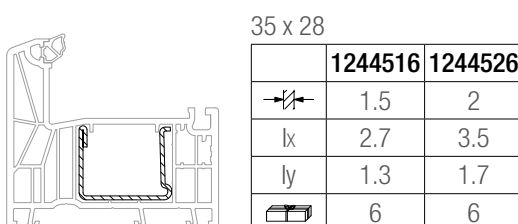
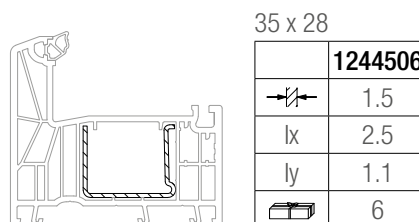
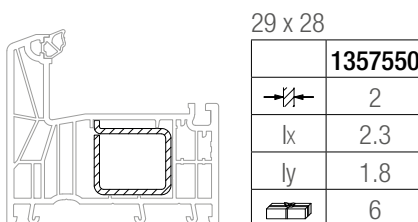
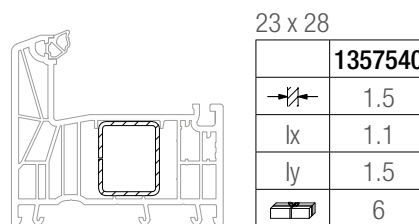
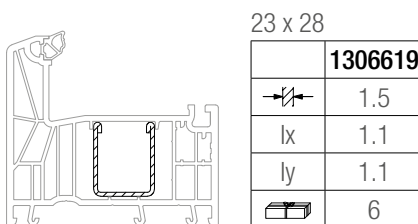

# SYNEGO®

## PROFILE PRINT

### Frame AD

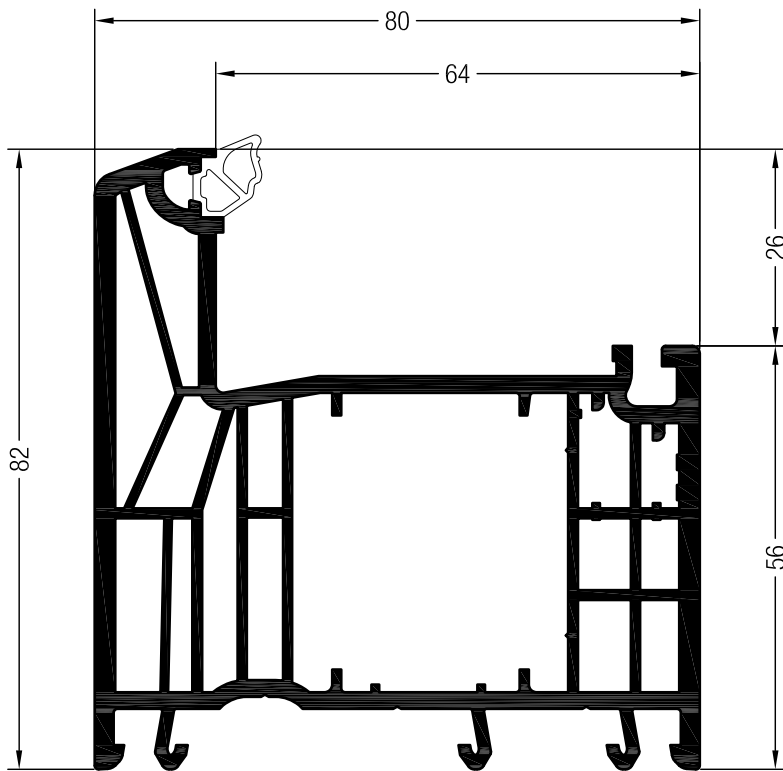



Frame 82 AD PULS SYNEGO®

1537015    

1567015    

 24



Frame 82 AD PULS SYNEGO®  
for aluminium cover profiles

1537018   

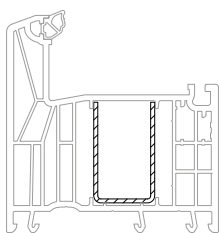
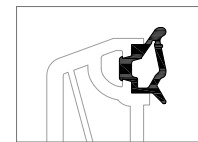
 24



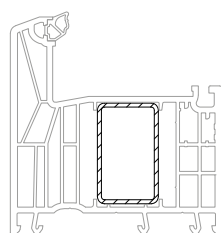

23 x 38

	<b>1357541</b>
	1.5
lx	1.4
ly	2.1
	6



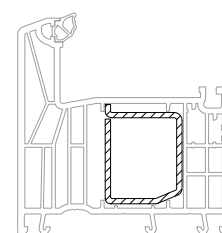

23 x 38

	<b>1357542</b>
	1.5
lx	1.5
ly	3.2
	6



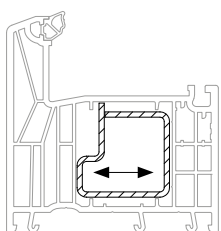

29 x 37.5

	<b>1357559</b>
	2
lx	2.9
ly	3.9
	6



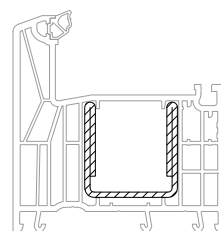

35 x 36

	<b>1357543</b>
	2
lx	3.6
ly	3.7
	6



35 x 36

	<b>1357608</b>
	2
lx	6.6
ly	3.9
	6

# SYNEGO®

## PROFILE PRINT

### Frame AD

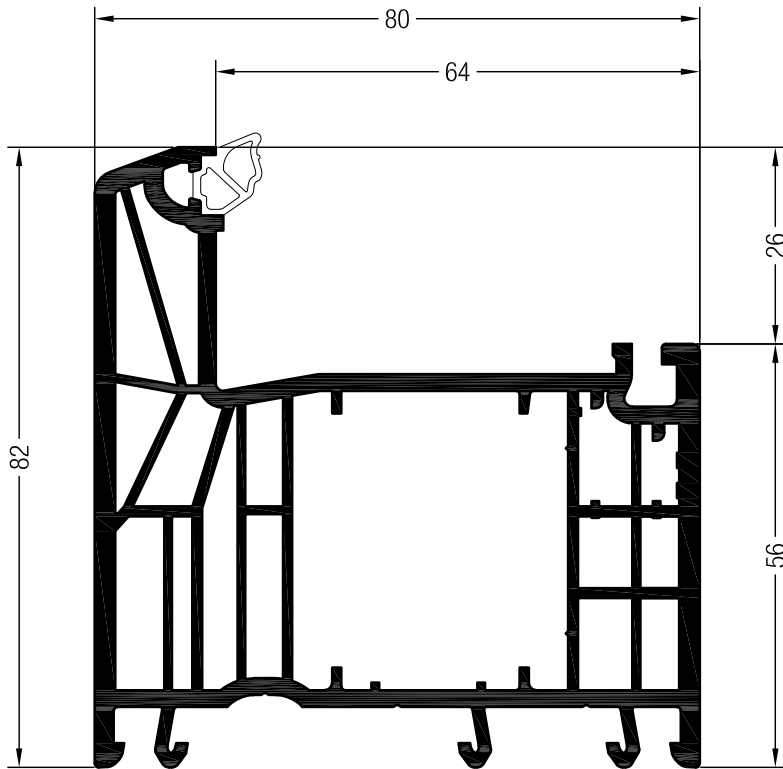



Frame 82 AD PULS SYNEGO®

1537615    

1567615    

 24



Frame 82 AD PULS SYNEGO®  
for aluminium cover profiles

1537618   

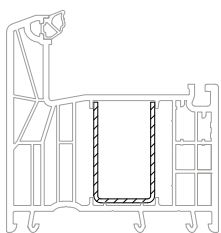
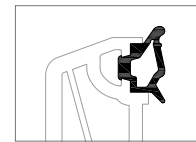
 24



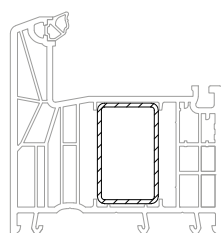

23 x 38

	<b>1357541</b>
	1.5
lx	1.4
ly	2.1
	6



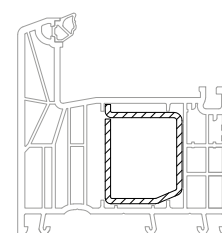

23 x 38

	<b>1357542</b>
	1.5
lx	1.5
ly	3.2
	6



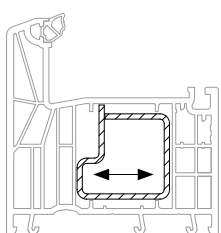

29 x 37.5

	<b>1357559</b>
	2
lx	2.9
ly	3.9
	6



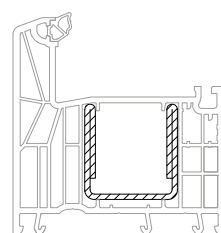

35 x 36

	<b>1357543</b>
	2
lx	3.6
ly	3.7
	6



35 x 36

	<b>1357608</b>
	2
lx	6.6
ly	3.9
	6

# SYNEGO®

## PROFILE PRINT

### Mullion-Transom AD

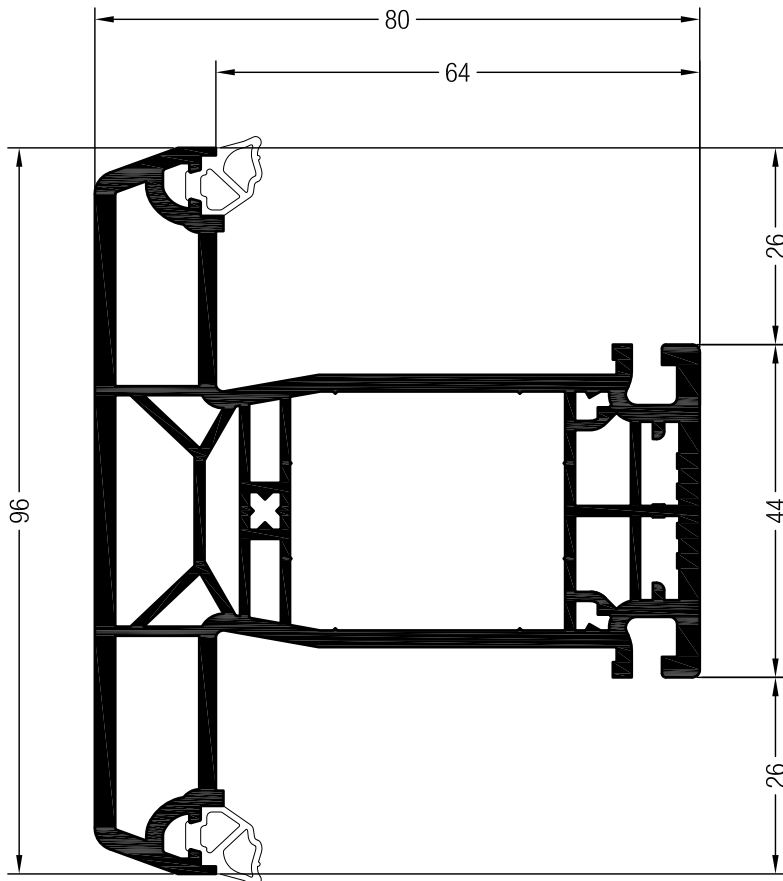

Mullion 96 AD PULS SYNEGO®

- 1537405
- 1567405 @
- 24

Mullion 96 AD PULS SYNEGO®  
for aluminium cover profiles

- 1537408
- 24

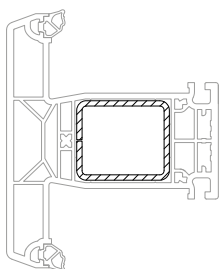
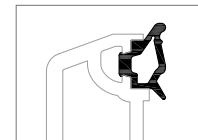

35 x 30

	1357666	1357544
	1.5	2
lx	3.2	4
ly	2.5	3.1
	6	6

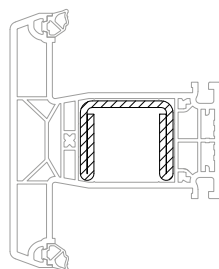

35 x 30

	1357551
	2.5
lx	6.6
ly	2.9
	6



# SYNEGO®

## PROFILE PRINT

### Mullion-Transom AD

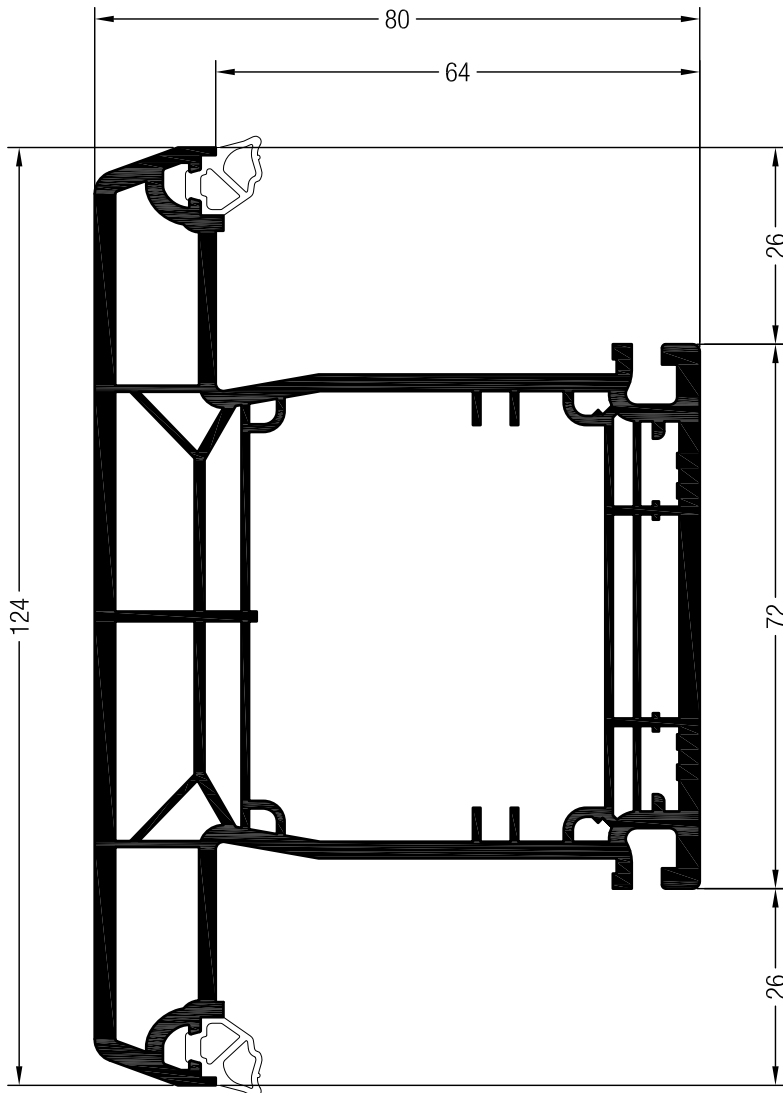

Mullion 124 AD SYNEGO®

1537415

@

1567415

@

12

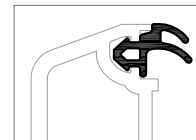

	1232881
	1232871

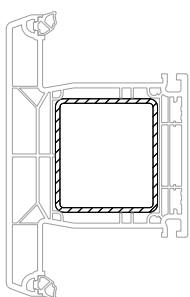

45 x 50

	<b>1357545</b>
	2
lx	11.1
ly	13.1
	6

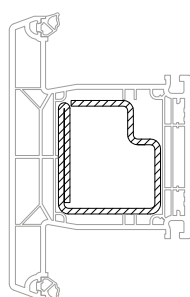

45 x 50

	<b>1357546</b>
	2.5
lx	14.1
ly	15.4
	6

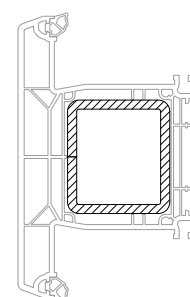

45 x 50

	<b>1357553</b>
	4
lx	19.3
ly	22.8
	6

# SYNEGO®

## PROFILE PRINT

### Frame MD

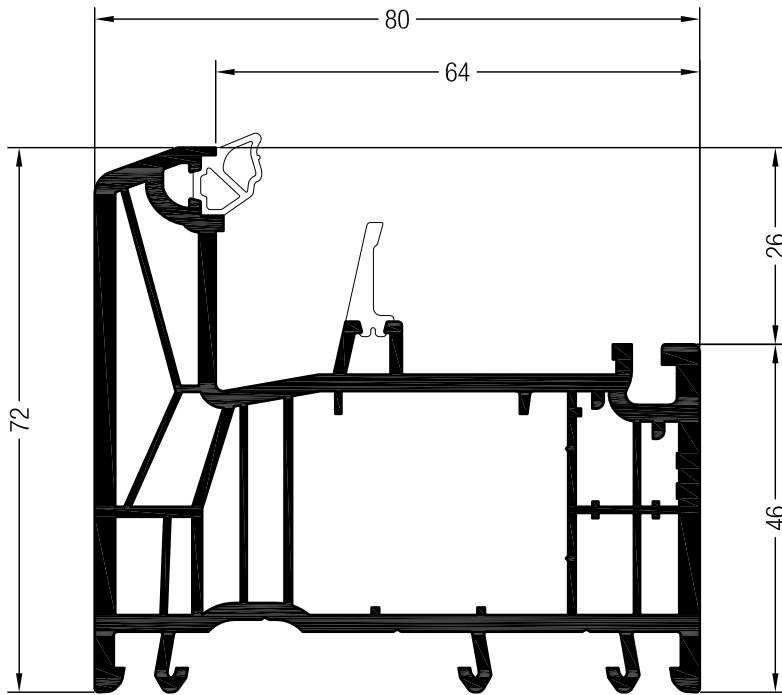

Frame 72 MD PULS SYNEGO®

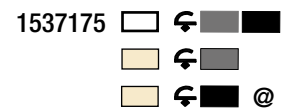

Frame 72 MD SYNEGO®



Frame 72 MD PULS SYNEGO®

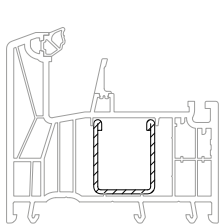
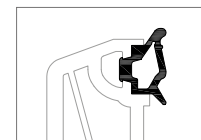

23 x 28

	<b>1306619</b>
	1.5
lx	1.1
ly	1.1
	6

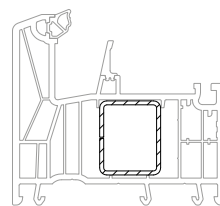

23 x 28

	<b>1357540</b>
	1.5
lx	1.1
ly	1.5
	6

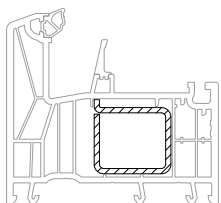

29 x 28

	<b>1357550</b>
	2
lx	2.3
ly	1.8
	6

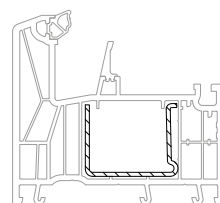

35 x 28

	<b>1244506</b>
	1.5
lx	2.5
ly	1.1
	6

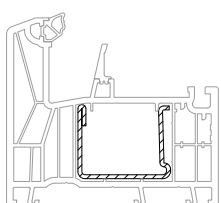

35 x 28

	<b>1244516</b>	<b>1244526</b>
	1.5	2
lx	2.7	3.5
ly	1.3	1.7
	6	6

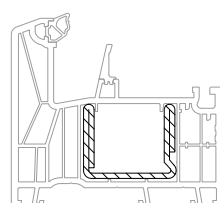

35 x 28

	<b>1244536</b>
	2
lx	5
ly	2
	6

# SYNEGO®

## PROFILE PRINT

### Frame MD

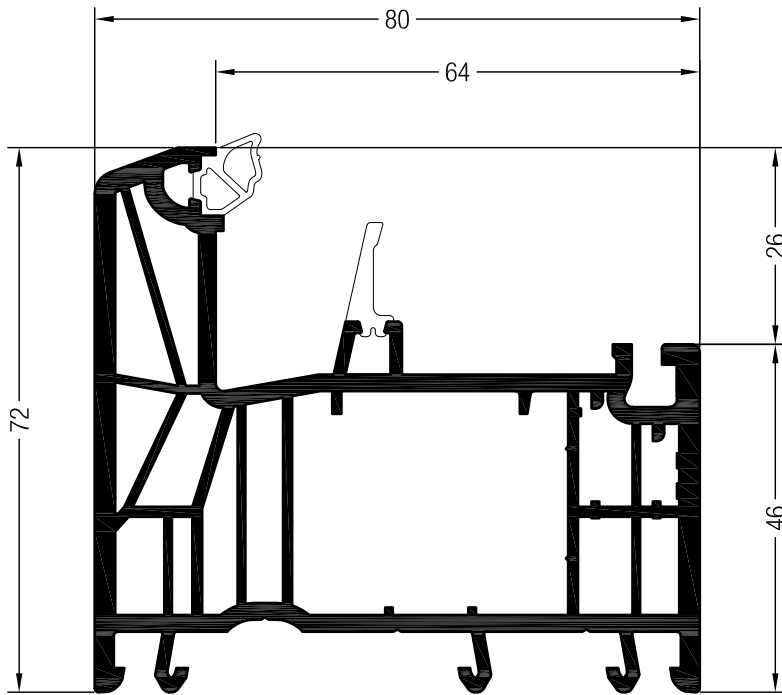

Frame 72 MD PULS SYNEGO®

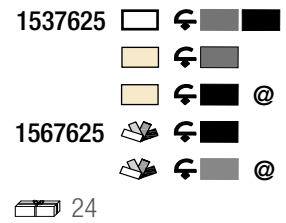

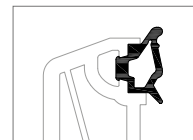
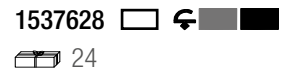

Frame 72 MD PULS SYNEGO®  
for aluminium cover profiles

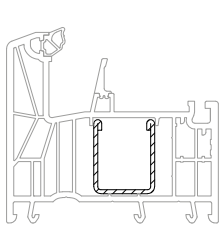

Supply availability as of 06.2018.



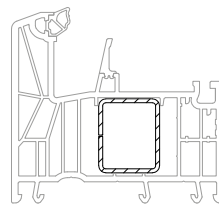

23 x 28

	<b>1306619</b>
	1.5
lx	1.1
ly	1.1
	6



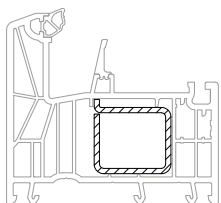

23 x 28

	<b>1357540</b>
	1.5
lx	1.1
ly	1.5
	6



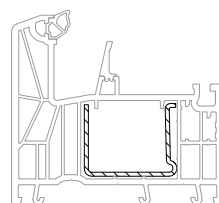

29 x 28

	<b>1357550</b>
	2
lx	2.3
ly	1.8
	6



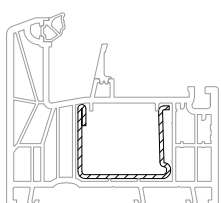

35 x 28

	<b>1244506</b>
	1.5
lx	2.5
ly	1.1
	6



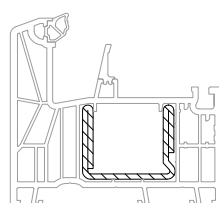

35 x 28

	<b>1244516</b>	<b>1244526</b>
	1.5	2
lx	2.7	3.5
ly	1.3	1.7
	6	6



35 x 28

	<b>1244536</b>
	2
lx	5
ly	2
	6

# SYNEGO®

## PROFILE PRINT

### Frame MD

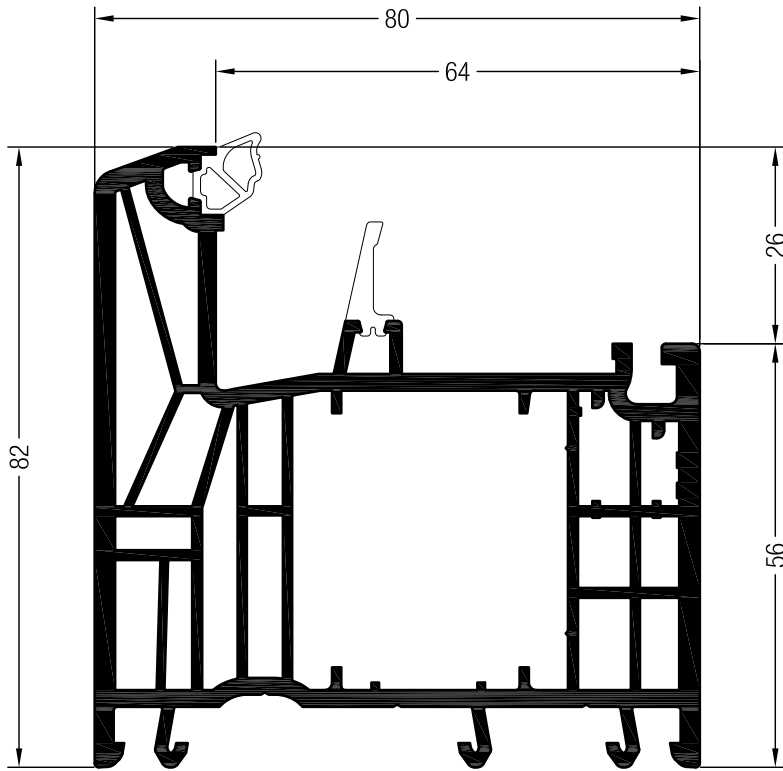

Frame 82 MD PULS SYNEGO®

- 1537115
- 1567115 @

Frame 82 MD PULS SYNEGO®  
for aluminium cover profiles

- 1537118
- 24

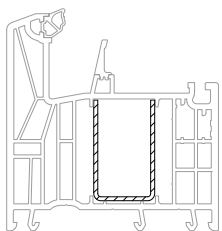
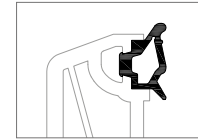

23 x 38

	1357541
	1.5
lx	1.4
ly	2.1
	6

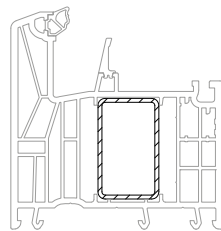

23 x 38

	1357542
	1.5
lx	1.5
ly	3.2
	6

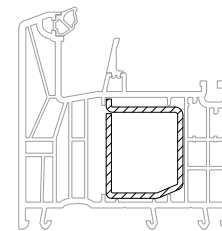

29 x 37.5

	1357559
	2
lx	2.9
ly	3.9
	6

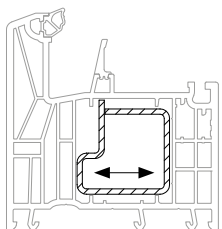

35 x 36

	1357543
	2
lx	3.6
ly	3.7
	6

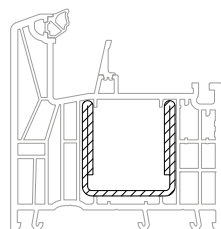

35 x 36

	1357608
	2
lx	6.6
ly	3.9
	6

# SYNEGO®

## PROFILE PRINT

### Frame MD

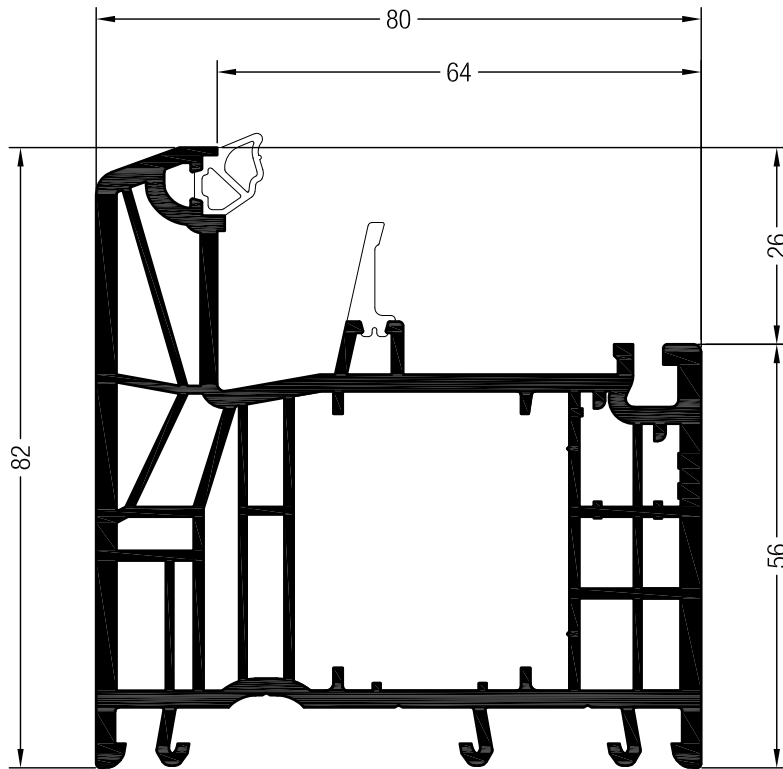

Frame 82 MD PULS SYNEGO®

1537635

1567635 @

24

Frame 82 MD PULS SYNEGO®  
for aluminium cover profiles

1537638

24

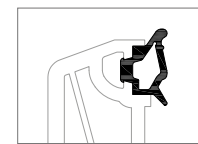

Supply availability as of 05.2018.

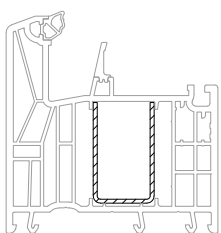

23 x 38

	<b>1357541</b>
	1.5
lx	1.4
ly	2.1
	6

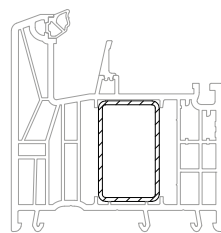

23 x 38

	<b>1357542</b>
	1.5
lx	1.5
ly	3.2
	6

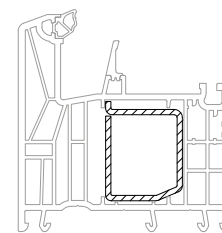

29 x 37.5

	<b>1357559</b>
	2
lx	2.9
ly	3.9
	6

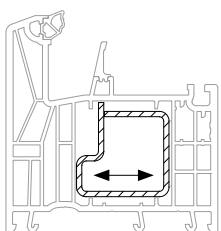

35 x 36

	<b>1357543</b>
	2
lx	3.6
ly	3.7
	6

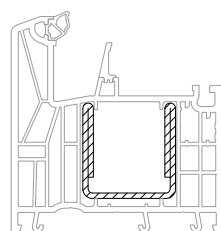

35 x 36

	<b>1357608</b>
	2
lx	6.6
ly	3.9
	6

# SYNEGO®

## PROFILE PRINT

### Frame MD

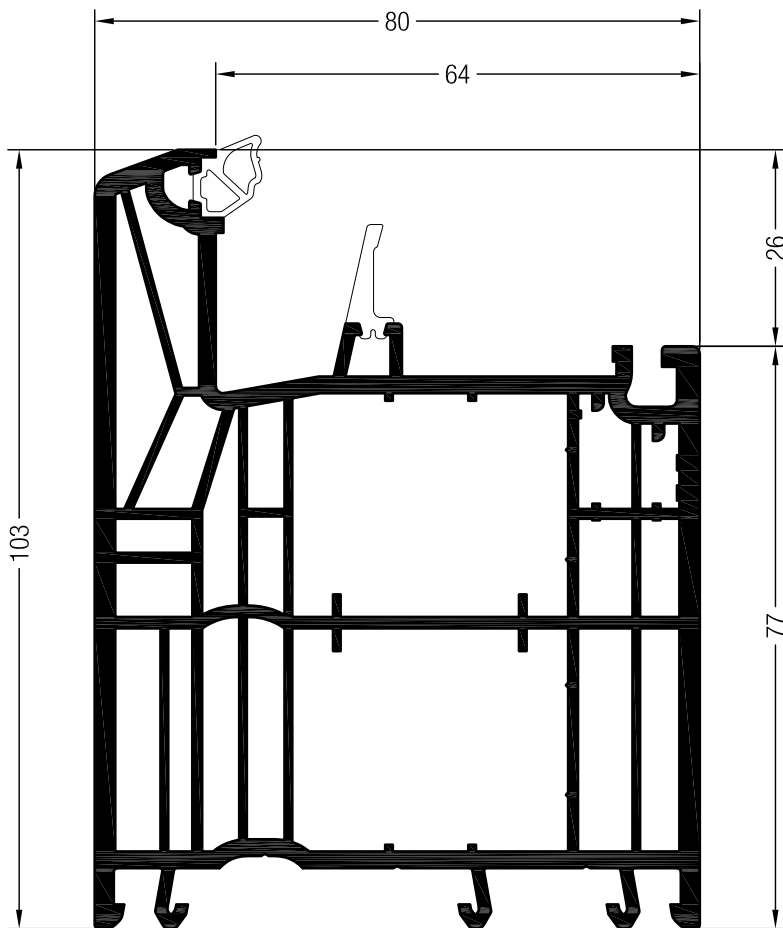

Frame 103 MD PULS SYNEGO®



1537135    

1567135    

  @

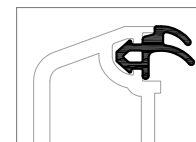

 24

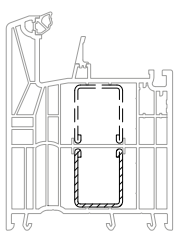

	1232881
	1232871



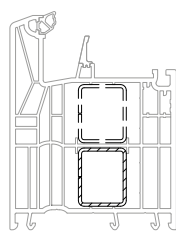

23 x 28

	<b>1306619</b>
	1.5
lx	1.1
ly	1.1
	6



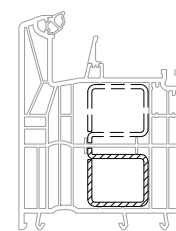

23 x 28

	<b>1357540</b>
	1.5
lx	1.1
ly	1.5
	6



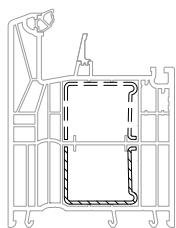

29 x 28

	<b>1357550</b>
	2
lx	2.3
ly	1.8
	6



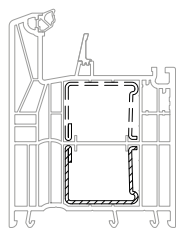

29 x 28

	<b>1244506</b>
	1.5
lx	2.5
ly	1.1
	6



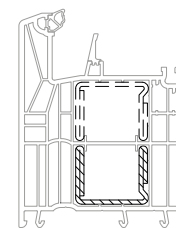

35 x 28

	<b>1244516</b>	<b>1244526</b>
	1.5	2
lx	2.7	3.5
ly	1.3	1.7
	6	6



35 x 28

	<b>1244536</b>
	2
lx	5
ly	2
	6



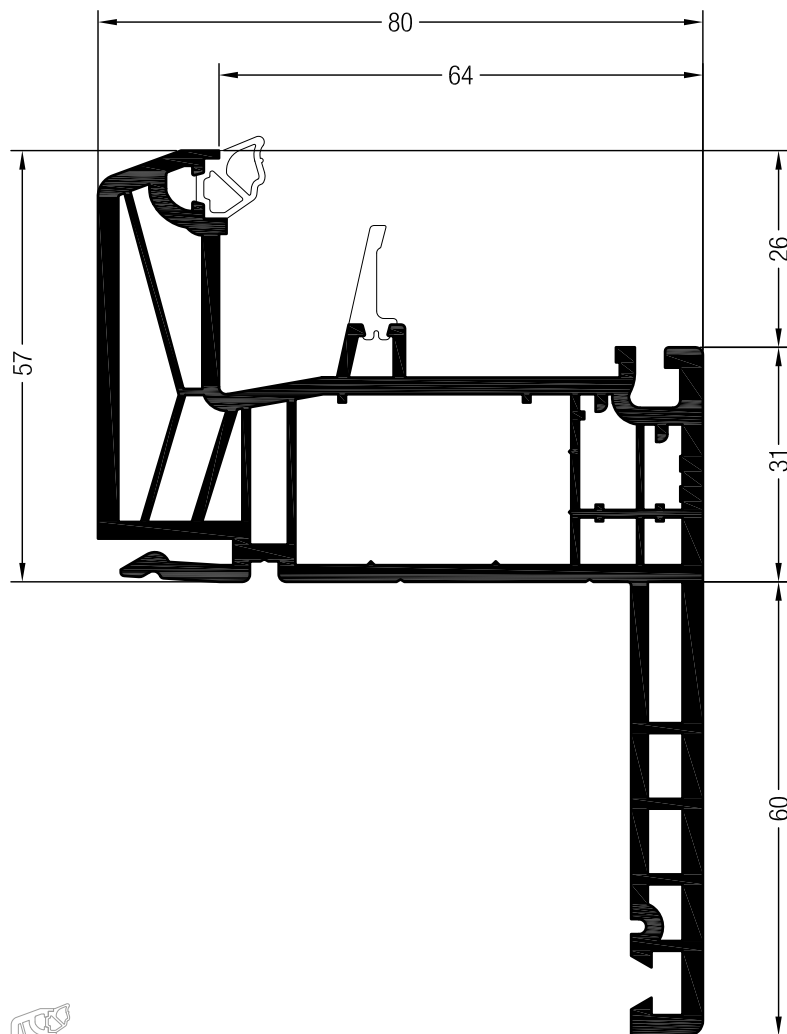

# SYNEGO®

## PROFILE PRINT

### Frame MD



Renovation frame 57/60 MD SYNEGO®

1537145    



    @

1567145     @

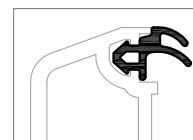
 24



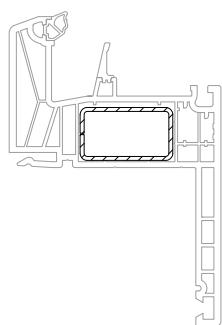

 E

	1232881
	1232871



35 x 20

	1239583
	1.5
lx	2.3
ly	0.98
	6

# SYNEGO®

## PROFILE PRINT

### Frame MD

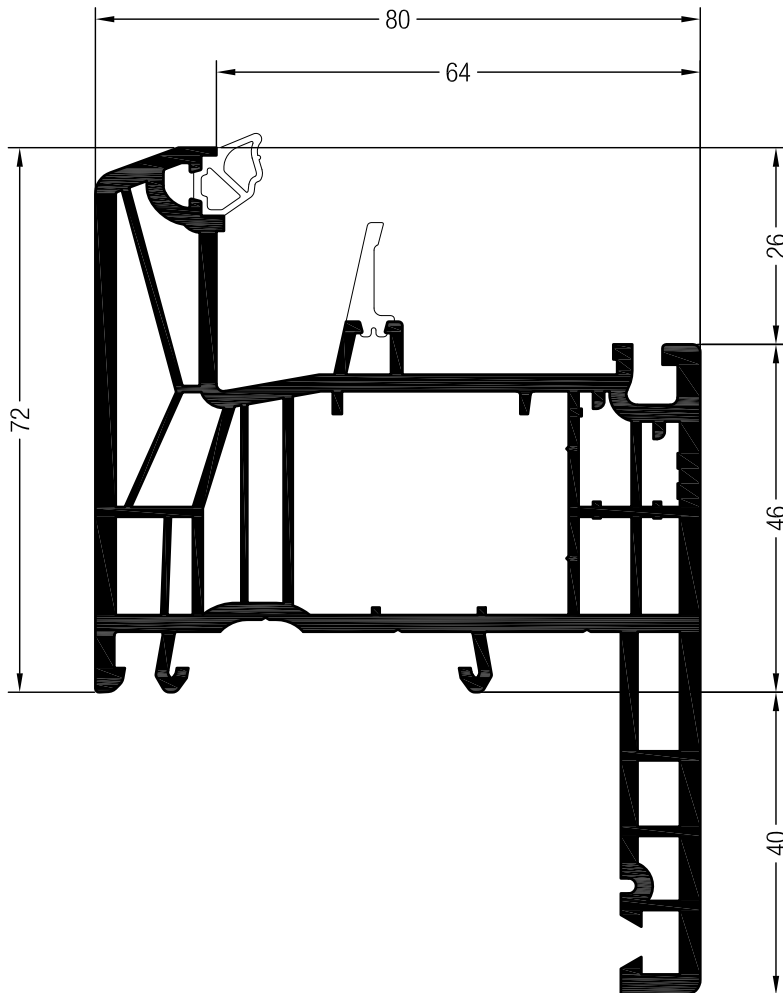

Frame 72/40 MD Puls SYNEGO®

- 1537165
- @
- 
- @
- 1567165 @
- 24

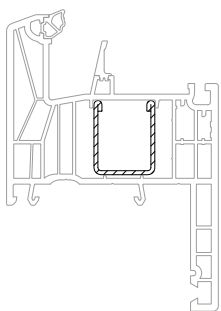

23 x 28

	<b>1306619</b>	
	1.5	
lx	1.1	
ly	1.1	
	6	

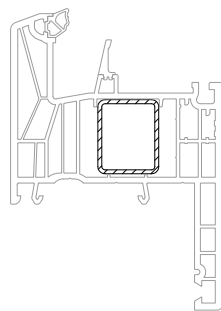

23 x 28

	<b>1357540</b>	
	1.5	
lx	1.1	
ly	1.5	
	6	

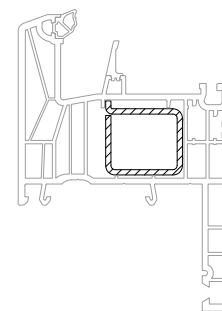

35 x 25

	<b>1357550</b>	
	2	
lx	2.3	
ly	1.8	
	6	

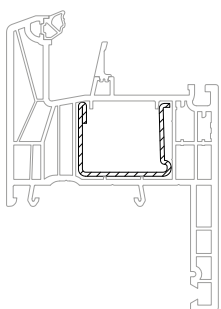

35 x 28

	<b>1244516</b>	<b>1244526</b>
	1.5	2
lx	2.7	3.5
ly	1.3	1.7
	6	6

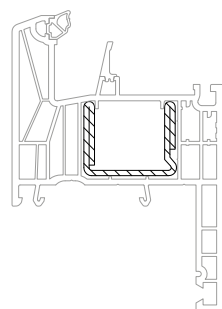

35 x 28

	<b>1244536</b>	
	2	
lx	5	
ly	2	
	6	



# SYNEGO®

## PROFILE PRINT

### Frame MD

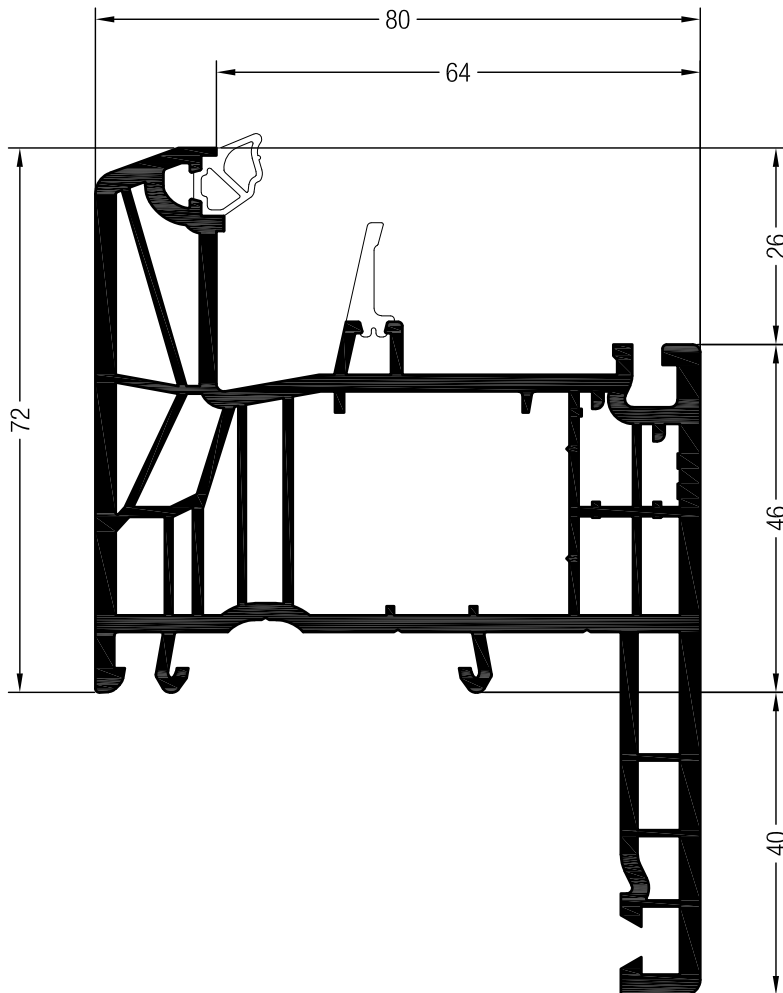

Frame 72/40 MD Puls SYNEGO®

- 1537195
- @
- 
- @
- 1567195 @
- 24

Supply availability as of 12.2018.

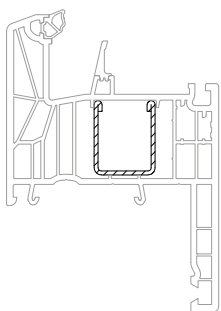

23 x 28

	<b>1306619</b>
	1.5
lx	1.1
ly	1.1
	6

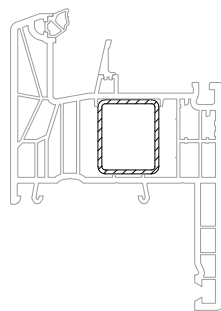

23 x 28

	<b>1357540</b>
	1.5
lx	1.1
ly	1.5
	6

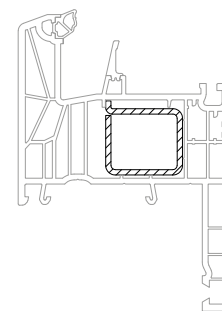

35 x 25

	<b>1357550</b>
	2
lx	2.3
ly	1.8
	6

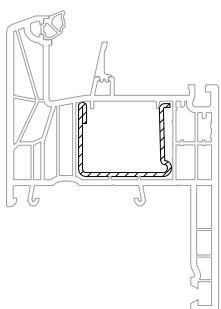

35 x 28

	<b>1244516</b>	<b>1244526</b>
	1.5	2
lx	2.7	3.5
ly	1.3	1.7
	6	6

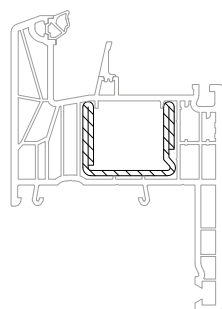

35 x 28

	<b>1244536</b>
	2
lx	5
ly	2
	6

# SYNEGO®

## PROFILE PRINT

### Frame MD

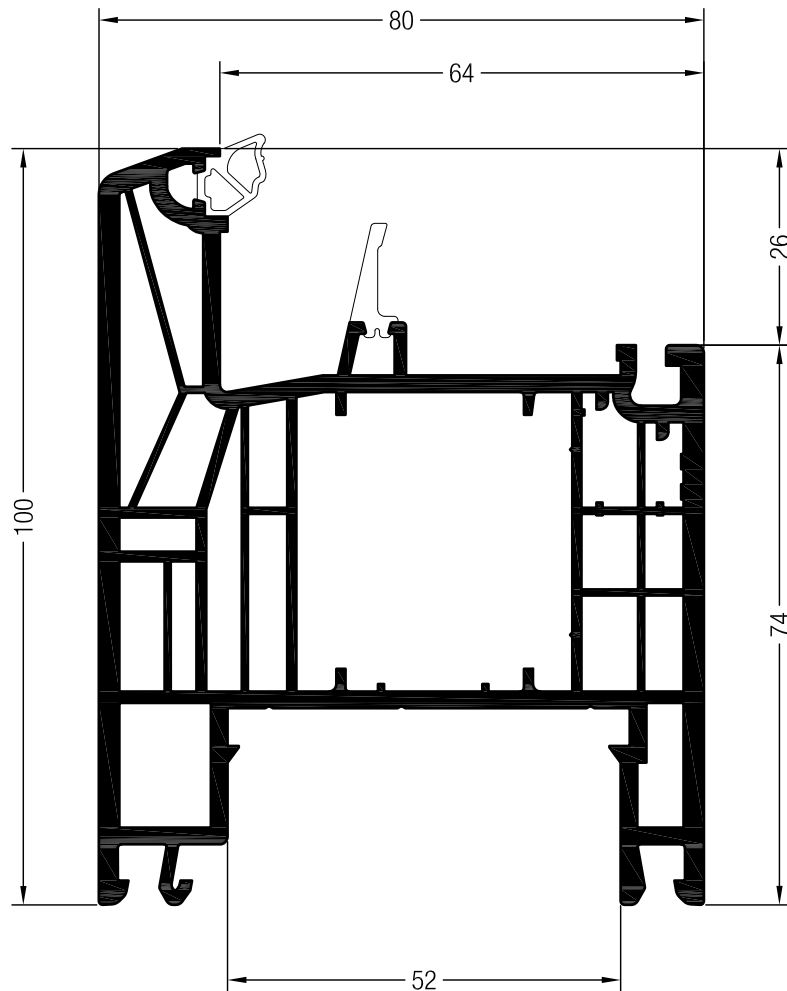

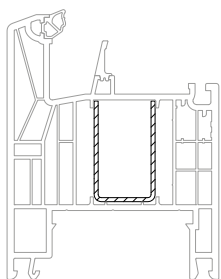
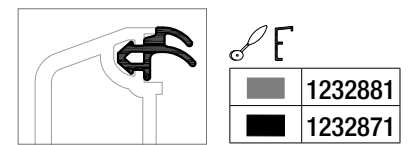

Frame 100 MD SYNEGO®

1537185   
 1567185  @  
 24



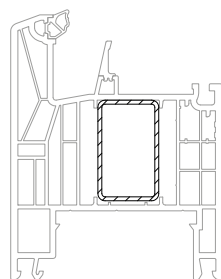

23 x 38

	<b>1357541</b>
	1.5
lx	1.4
ly	2.1
	6



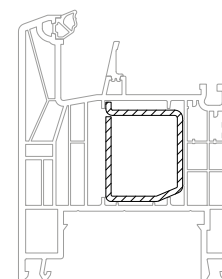

23 x 38

	<b>1357542</b>
	1.5
lx	1.5
ly	3.2
	6



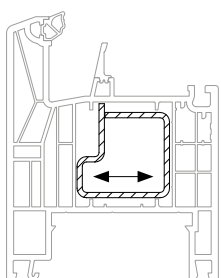

29 x 37.5

	<b>1357559</b>
	2
lx	2.3
ly	1.8
	6



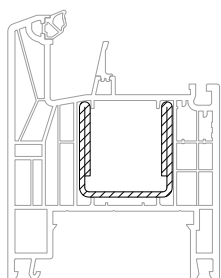

35 x 36

	<b>1357543</b>
	2
lx	3.6
ly	3.7
	6



35 x 36

	<b>1357608</b>
	2
lx	6.6
ly	3.9
	6

# SYNEGO®

## PROFILE PRINT

### Mullion-Transom MD

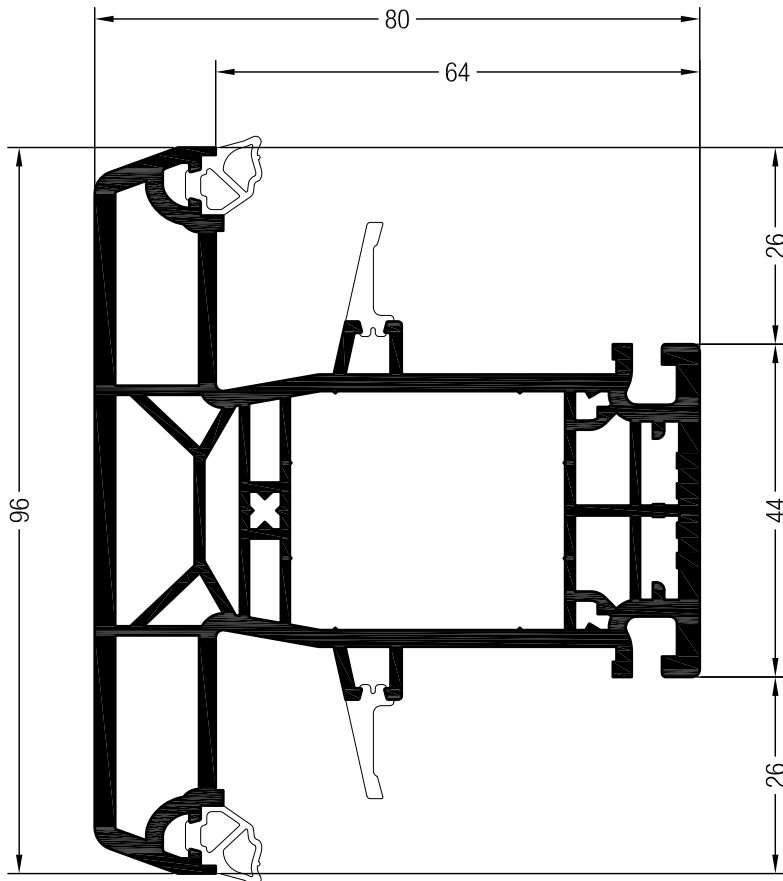

Mullion 96 MD PULS SYNEGO®

1537505 

  

1567505   

  @

 24



Mullion 96 MD PULS SYNEGO® for aluminium cover profiles

1537508 

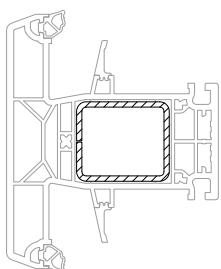
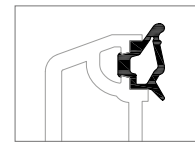
 24



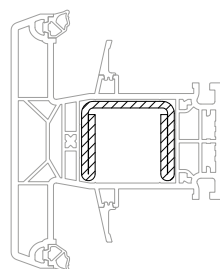

35 x 30

	1357666	1357544
	1.5	2
lx	3.2	4
ly	2.5	3.1
	6	6



35 x 30

	1357551
	2.5
lx	6.6
ly	2.9
	6

# SYNEGO®

## PROFILE PRINT

### Mullion-transom MD

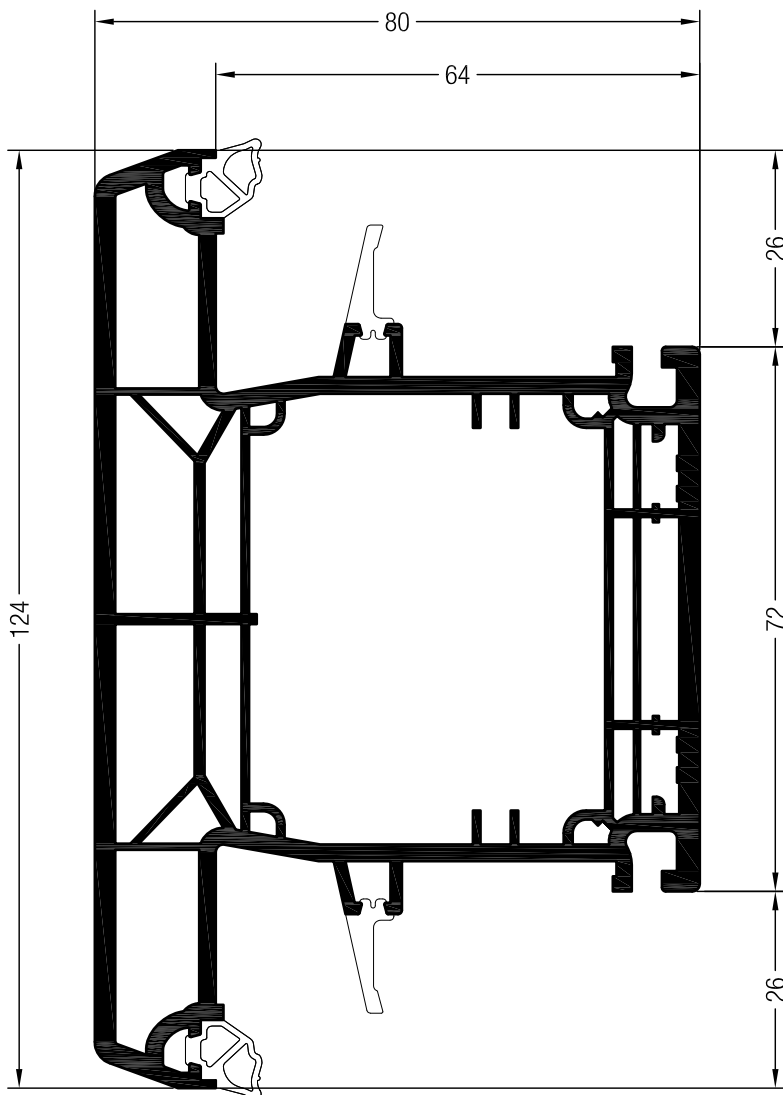

Mullion 124 MD SYNEGO®

1537515

1567515

12

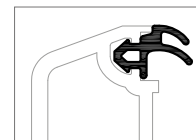

E

	1232881
	1232871

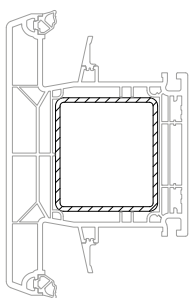

45 x 50

	<b>1357545</b>
	2
lx	11.1
ly	13.1
	6

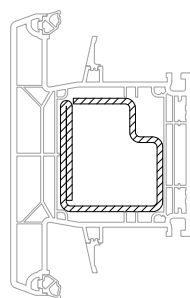

45 x 50

	<b>1357546</b>
	2.5
lx	14.1
ly	15.4
	6

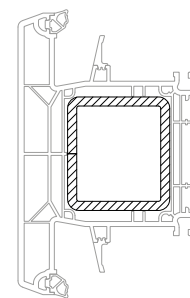

45 x 50

	<b>1357553</b>
	4
lx	19.3
ly	22.8
	6

# SYNEGO®

## PROFILE PRINT

### Compensating profile

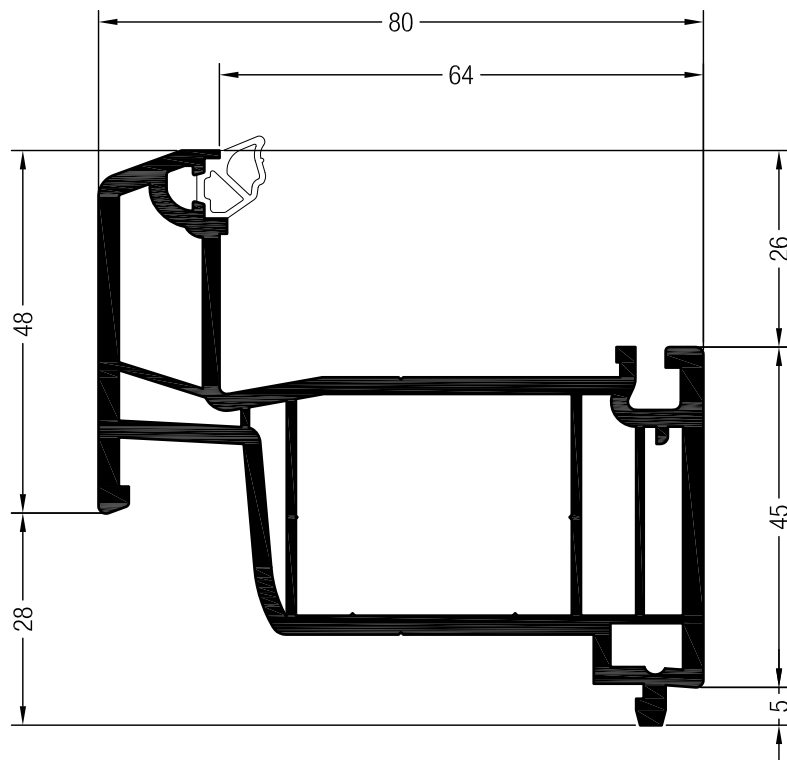

Compensating profile 48 SYNEGO®  
(in connection with sash 59 at the top)

1537335

1567335 @

12

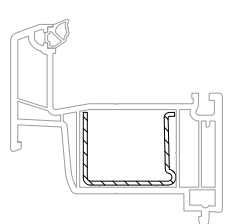

35 x 28

	<b>1244506</b>
	1.5
lx	2.5
ly	1.1
	6

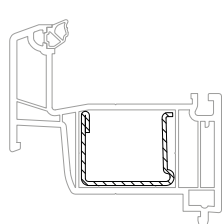

35 x 28

	<b>1244516</b>	<b>1244526</b>
	1.5	2
lx	2.7	3.5
ly	1.3	1.7
	6	6

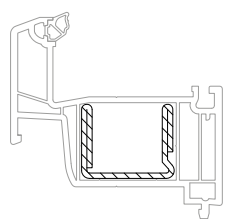

35 x 28

	<b>1244536</b>
	2
lx	5
ly	2
	6



# SYNEGO®

## PROFILE PRINT

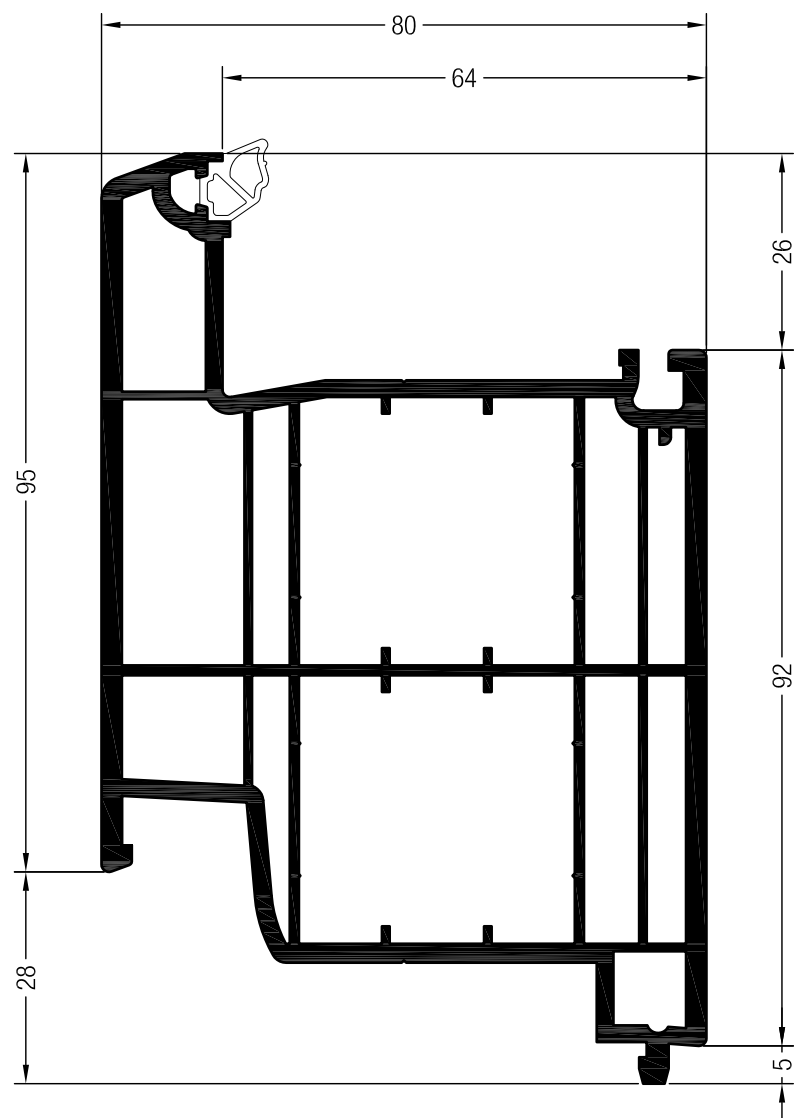
### Compensating profile



Compensating profile 95 SYNEGO®  
(in connection with front door sash at the top)



1537325   

1567325    @

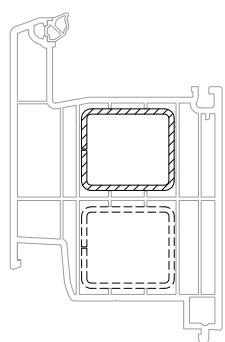
 12



35 x 30

	<b>1357544</b>
	2
lx	4
ly	3.1
	6

# SYNEGO®

## PROFILE PRINT

### Blade

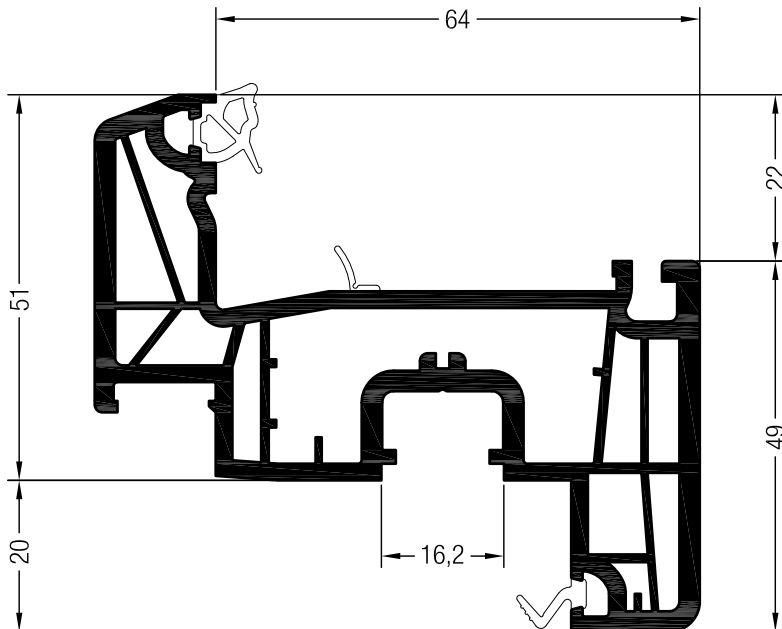

Sash Z 51 SYNEGO®

1537205

1567205

24

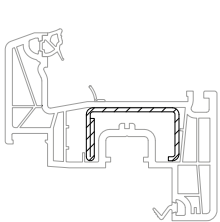

35 x 20

	1261831	1261841
	1.5	2
lx	2.5	3.1
ly	0.56	0.69
	6	6

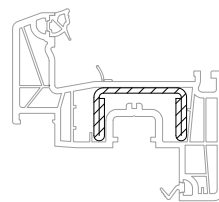

35 x 20

	1351893
	2
lx	3.8
ly	0.77
	6

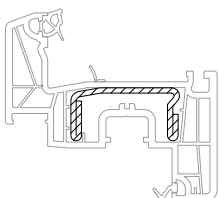

41 x 20

	1357590
	2
lx	4.9
ly	0.8
	6

# SYNEGO®

## PROFILE PRINT

### Blade

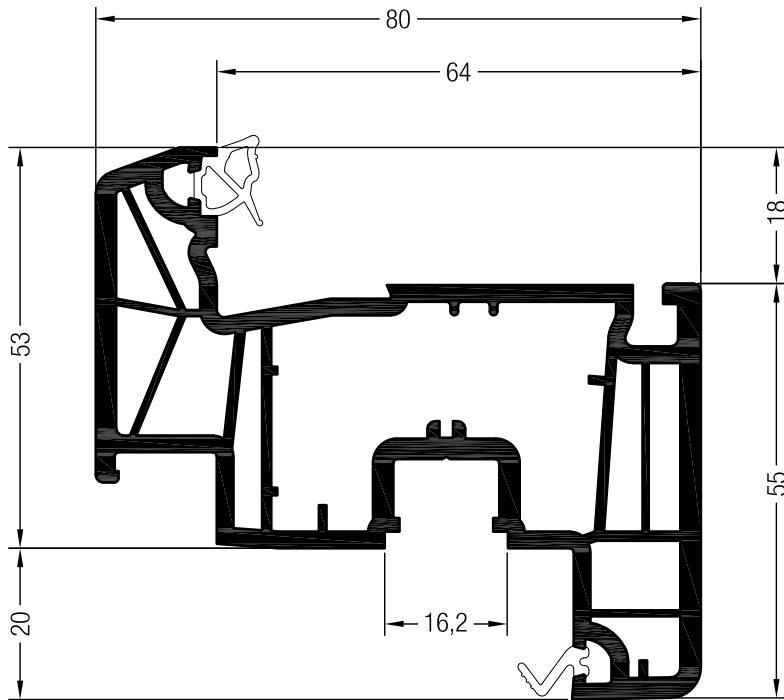

Glass bonding sash Z 53 PULS SYNEGO®

1537285

1567285

24

Supply availability as of 05.2018.

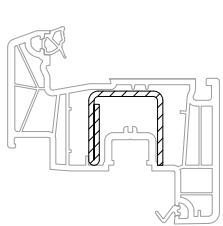

28 x 28

	1357610	1313130
	1.5	2
lx	2	2.5
ly	1.2	1.6
	6	6

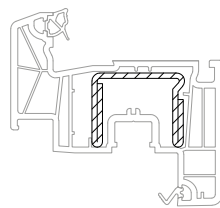

30 x 28

	1306617
	2
lx	3.7
ly	1.9
	6

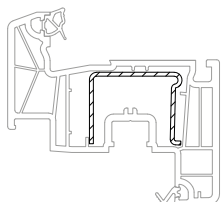

35 x 28

	1244506
	1.5
lx	2.5
ly	1.1
	6

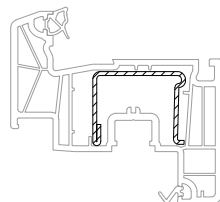

35 x 28

	1244516	1244526
	1.5	2
lx	2.7	3.5
ly	1.3	1.7
	6	6

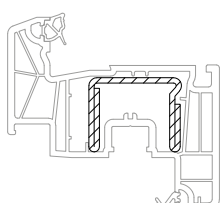

35 x 28

	1244536
	2
lx	5
ly	2
	6

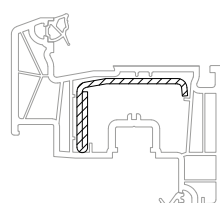

41.8 x 28

	1352515
	2
lx	3.3
ly	1.4
	6

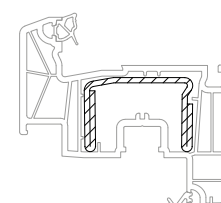

41 x 28

	1352512
	2
lx	7.1
ly	2.1
	6



### Blade

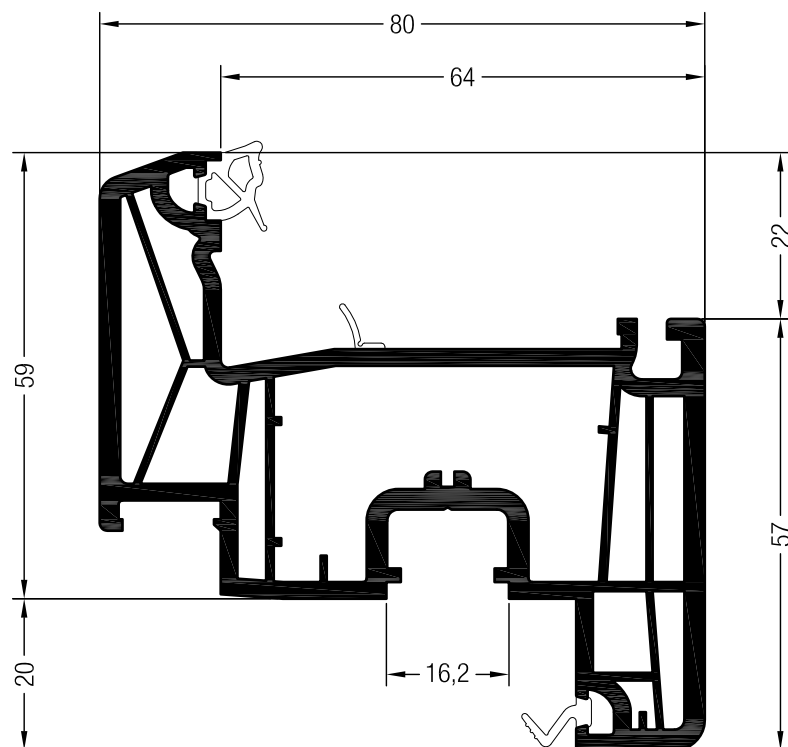

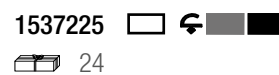

Sash Z 59 PULS SYNEGO®

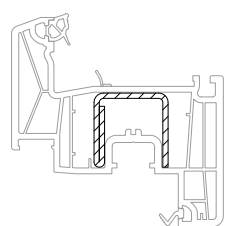

Sash Z 59 SYNEGO®



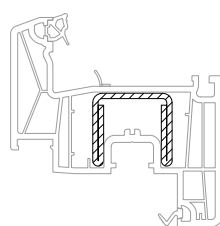

28 x 28

	1357610	1313130
	1.5	2
lx	2	2.5
ly	1.2	1.6
	6	6



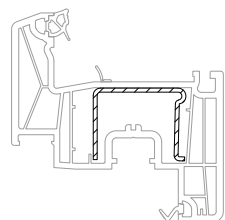

30 x 28

	1306617
	2
lx	3.7
ly	1.9
	6



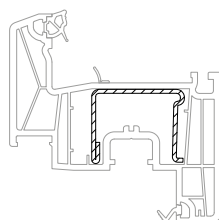

35 x 28

	1244506
	1.5
lx	2.5
ly	1.1
	6



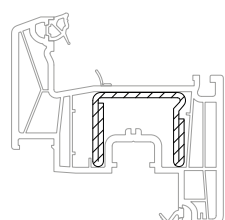

35 x 28

	1244516	1244526
	1.5	2
lx	2.7	3.5
ly	1.3	1.7
	6	6



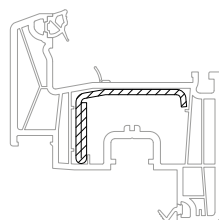

35 x 28

	1244536
	2
lx	5
ly	2
	6



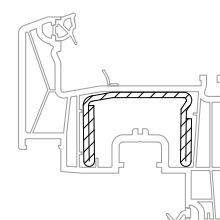

41.8 x 28

	1352515
	2
lx	3.3
ly	1.4
	6



41 x 28

	1352512
	2
lx	7.1
ly	2.1
	6

# SYNEGO®

## PROFILE PRINT

### Sash

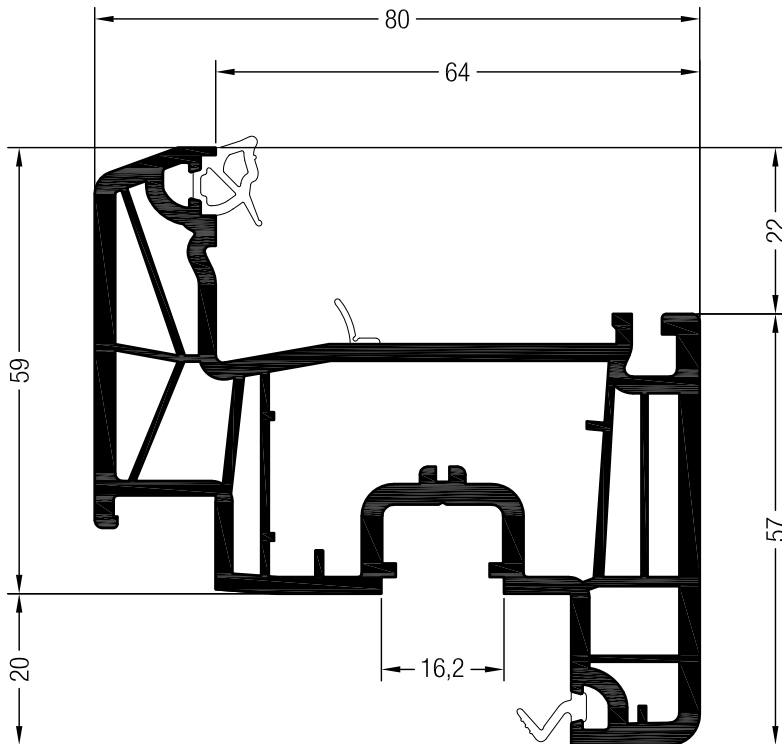

Sash Z 59 PULS SYNEGO®

- 1537555
- 1537525
- 1567525
- @
- 24

Supply availability as of 07.2018.

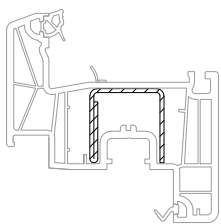

28 x 28

	1357610	1313130
	1.5	2
lx	2	2.5
ly	1.2	1.6
	6	6

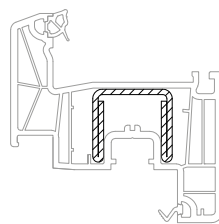

30 x 28

	1306617
	2
lx	3.7
ly	1.9
	6

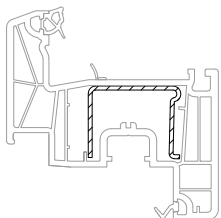

35 x 28

	1244506
	1.5
lx	2.5
ly	1.1
	6

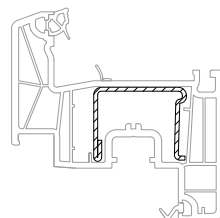

35 x 28

	1244516	1244526
	1.5	2
lx	2.7	3.5
ly	1.3	1.7
	6	6

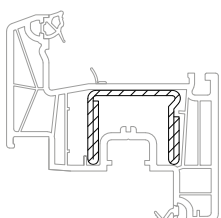

35 x 28

	1244536
	2
lx	5
ly	2
	6

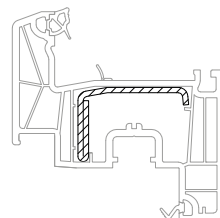

41.8 x 28

	1352515
	2
lx	3.3
ly	1.4
	6

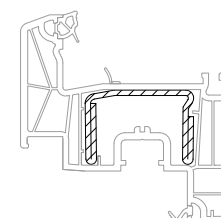

41 x 28

	1352512
	2
lx	7.1
ly	2.1
	6

# SYNEGO®

## PROFILE PRINT

### Sash

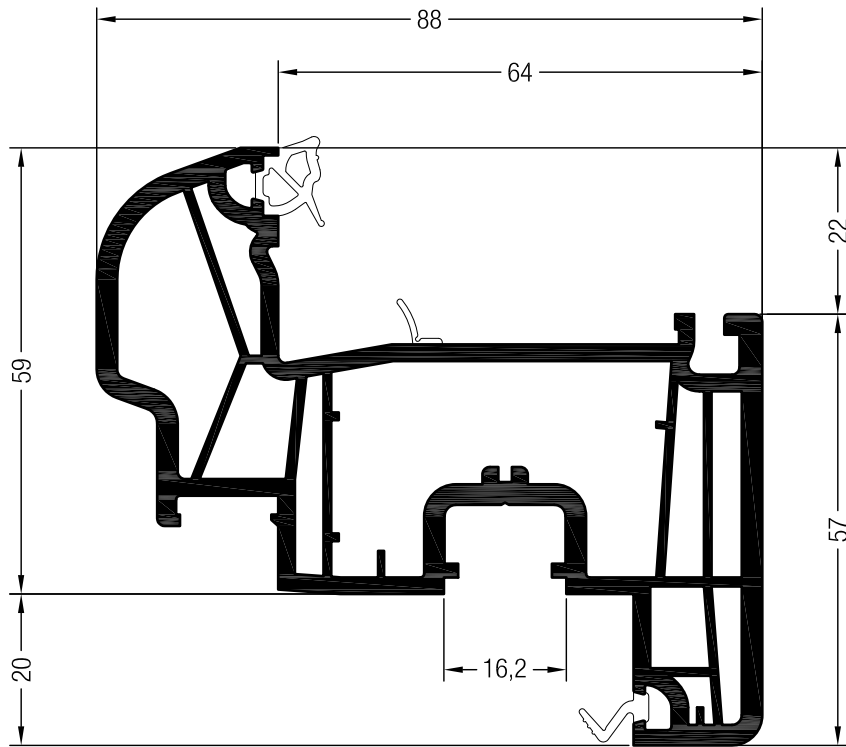

Sash 59 round PULS SYNEGO®

- 1537245
- 
- 1567245
- @
- 24

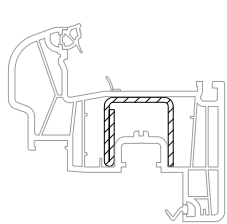

28 x 28

	1357610	1313130
	1.5	2
lx	2	2.5
ly	1.2	1.6
	6	6

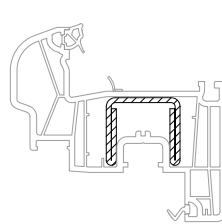

30 x 28

	1306617
	2
lx	3.7
ly	1.9
	6

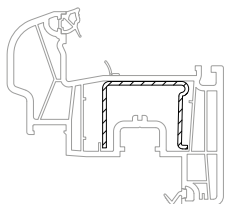

35 x 28

	1244506
	1.5
lx	2.5
ly	1.1
	6

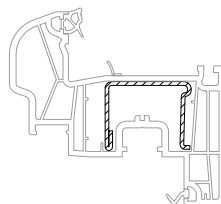

35 x 28

	1244516	1244526
	1.5	2
lx	2.7	3.5
ly	1.3	1.7
	6	6

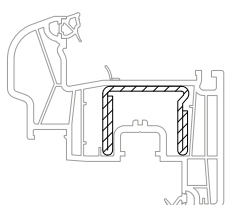

35 x 28

	1244536
	2
lx	5
ly	2
	6

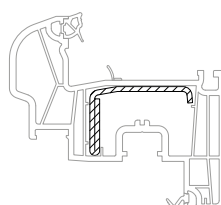

41.8 x 28

	1352515
	2
lx	3.3
ly	1.4
	6

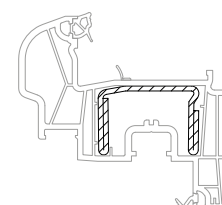

41 x 28

	1352512
	2
lx	7.1
ly	2.1
	6

# SYNEGO®

## PROFILE PRINT

### Sash

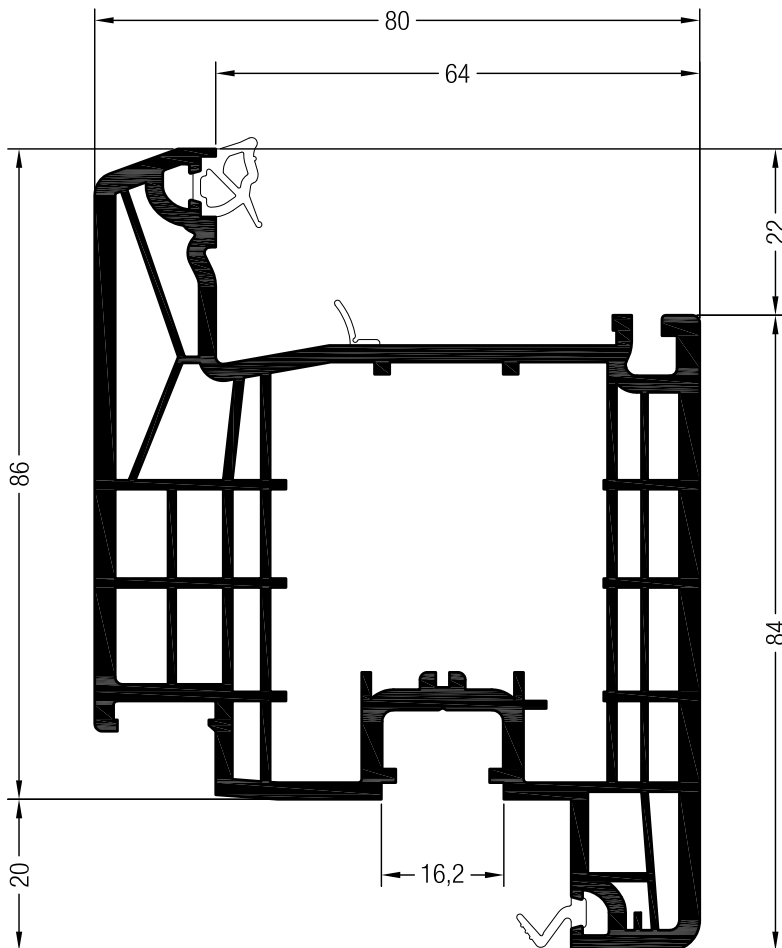

Sash Z 86 SYNEGO®

- 1537235
- 1567235
- @
- 24

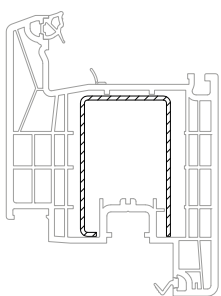

34 x 53

	<b>1357547</b>
	1.5
lx	4.6
ly	6.5
	6

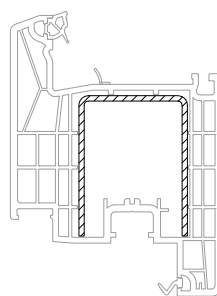

41 x 53

	<b>1357548</b>
	2
lx	8.7
ly	8.4
	6

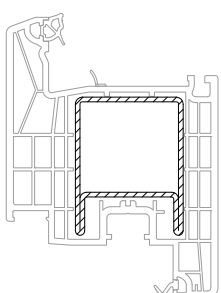

41 x 52

	<b>1357597</b>
	1.75
lx	9.7
ly	10.5
	6

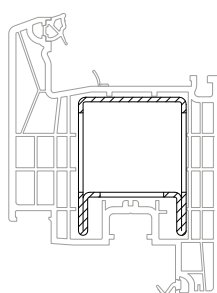

41 x 52

	<b>1357598</b>
	1.75
preassembled for lock side	
	2.2







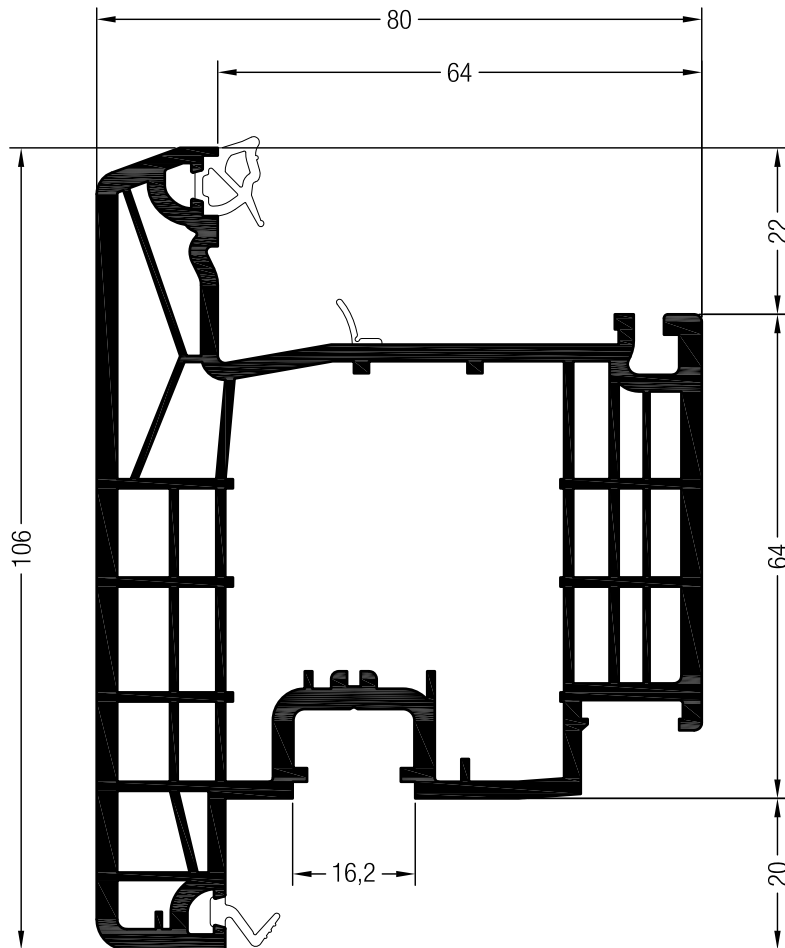





# SYNEGO®

## PROFILE PRINT



### Sash





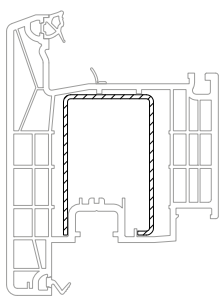

Sash T 106 SYNEGO®

- 1537315   
-   
- 1567315   
-    @
-  12

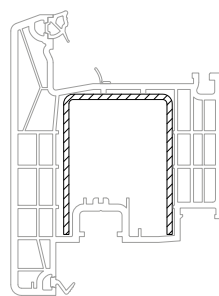



34 x 53	
	<b>1357547</b>
	1.5
lx	4.6
ly	6.5
	6



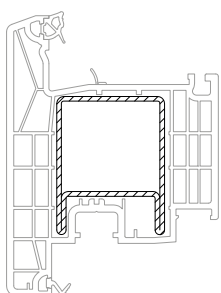

41 x 53	
	<b>1357548</b>
	2
lx	8.7
ly	8.4
	6

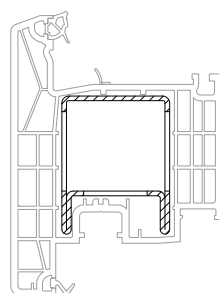

41 x 52	
	<b>1357597</b>
	1.75
lx	9.7
ly	10.5
	6



41 x 52	
	<b>1357598</b>
	1.75
preassembled for lock side	
	2.2

# SYNEGO®

## PROFILE PRINT

### Sash

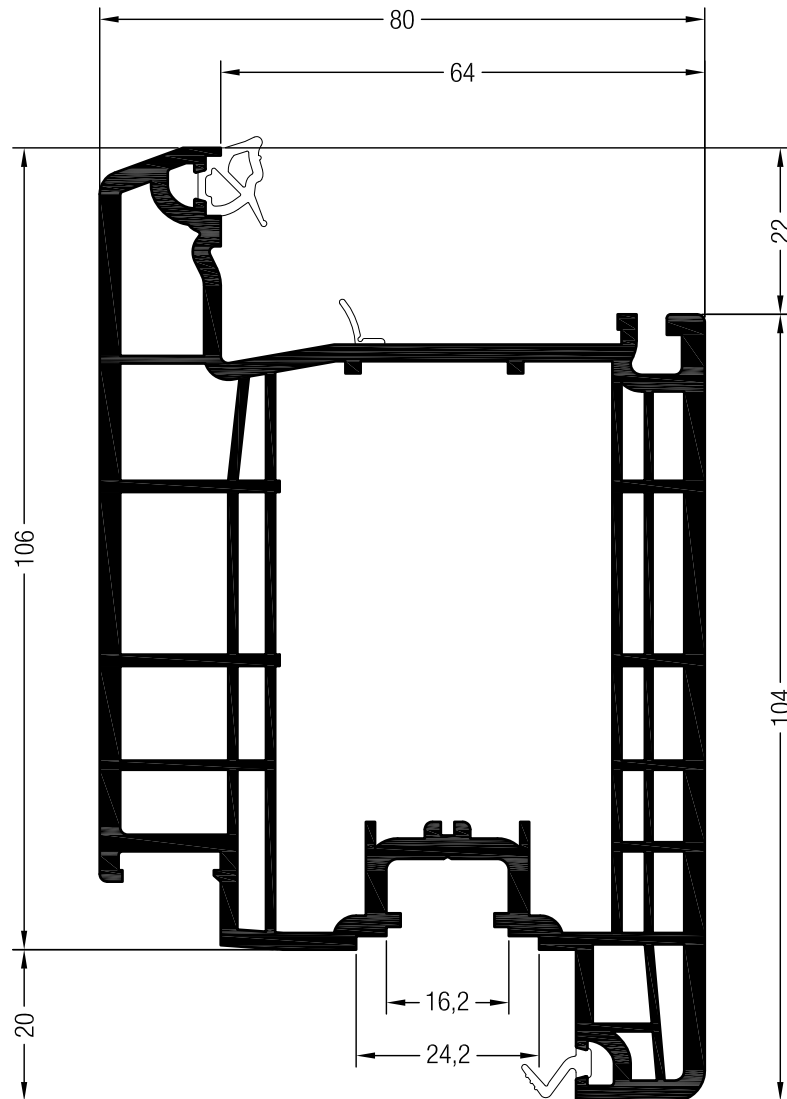

Entry door sash Z SYNEGO®

1537295

1567295

@

13

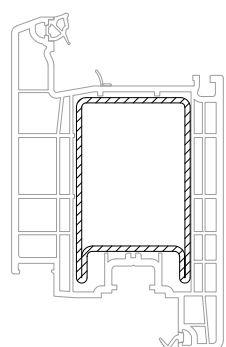

43 x 70

	<b>1357549</b>
	2
lx	14.9
ly	27.1
	6

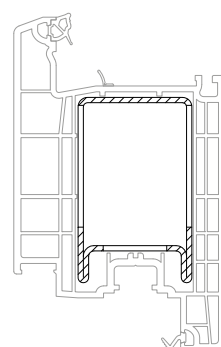

43 x 70

	<b>1357556</b>
	2
preassembled for lock side	
	2.4

# SYNEGO®

## PROFILE PRINT

### Sash

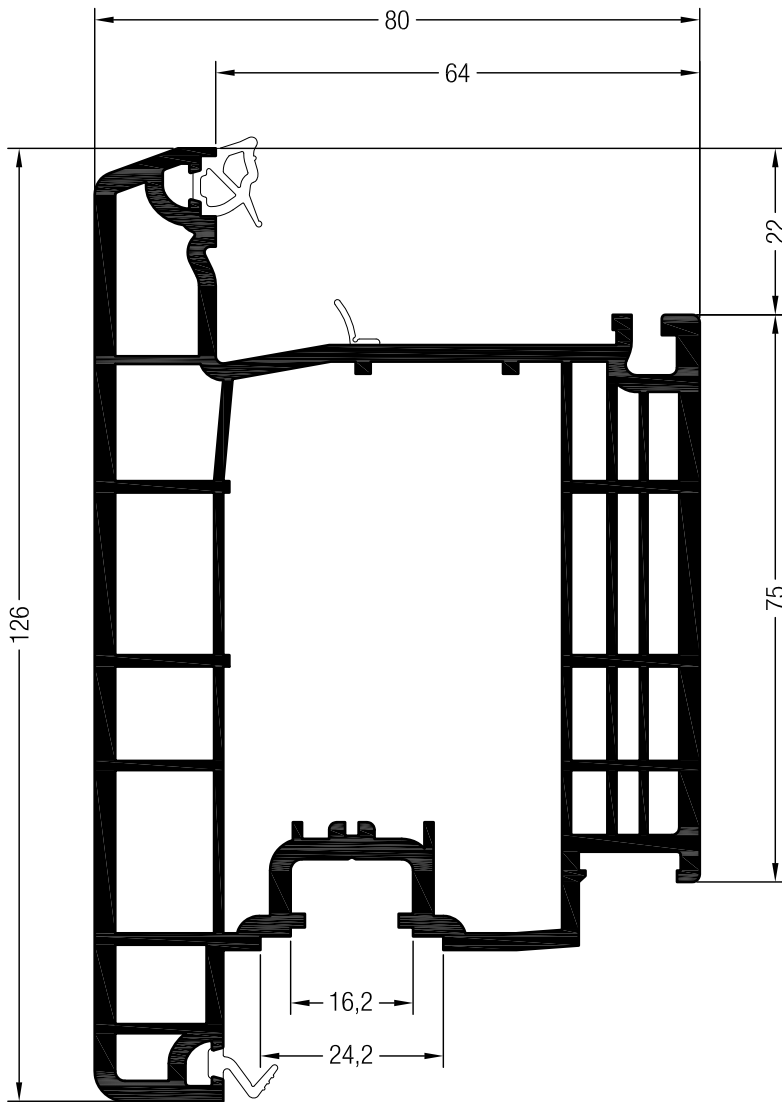

Entry door sash T SYNEGO®

- 1537305
- 
- 1567305
- @
- 13

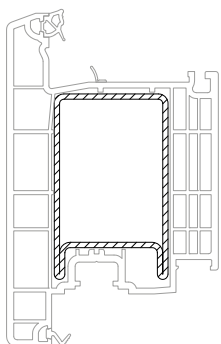

43 x 70

	<b>1357549</b>
	2
lx	14.9
ly	27.1
	6

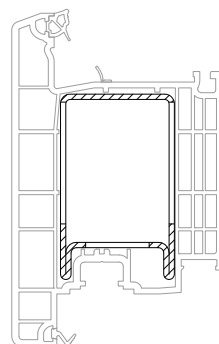

43 x 70

	<b>1357556</b>
	2
preassembled for lock side	
	2.4







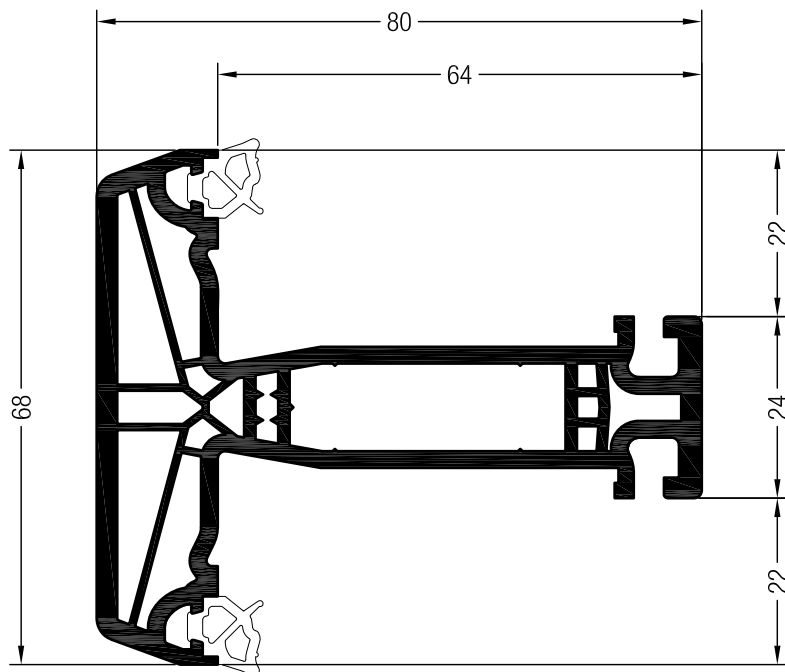





# SYNEGO®

## PROFILE PRINT

### Sash muntins



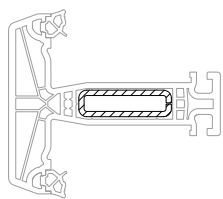

#### Muntin 68 SYNEGO®

- 1537425   
  -   
  - 1567425   
  -   @
-  36



35 x 10

	<b>1261801</b>
	2
lx	1.8
ly	0.22
	6









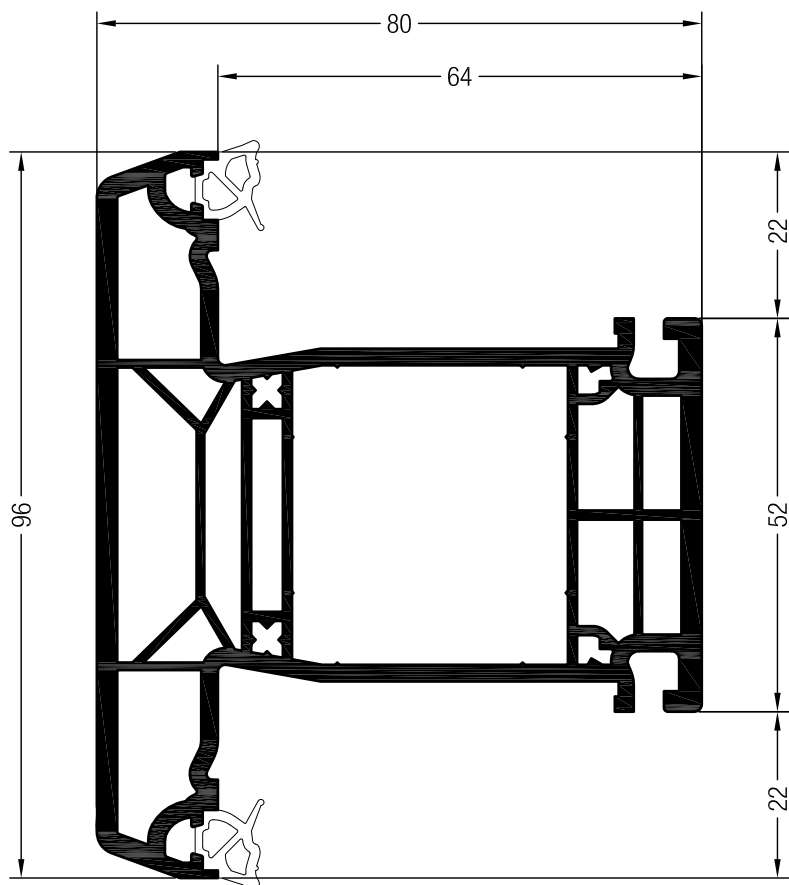



# SYNEGO®

## PROFILE PRINT

### Sash muntins



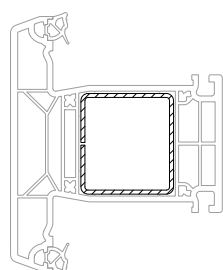

#### Muntin 96 SYNEGO®

- 1537435   
- 1567435   
-    @
-  24



35 x 38

	<b>1357609</b>
	1.5
lx	3.8
ly	4.4
	6

### Profiles for multi-sash windows without fixed mullions

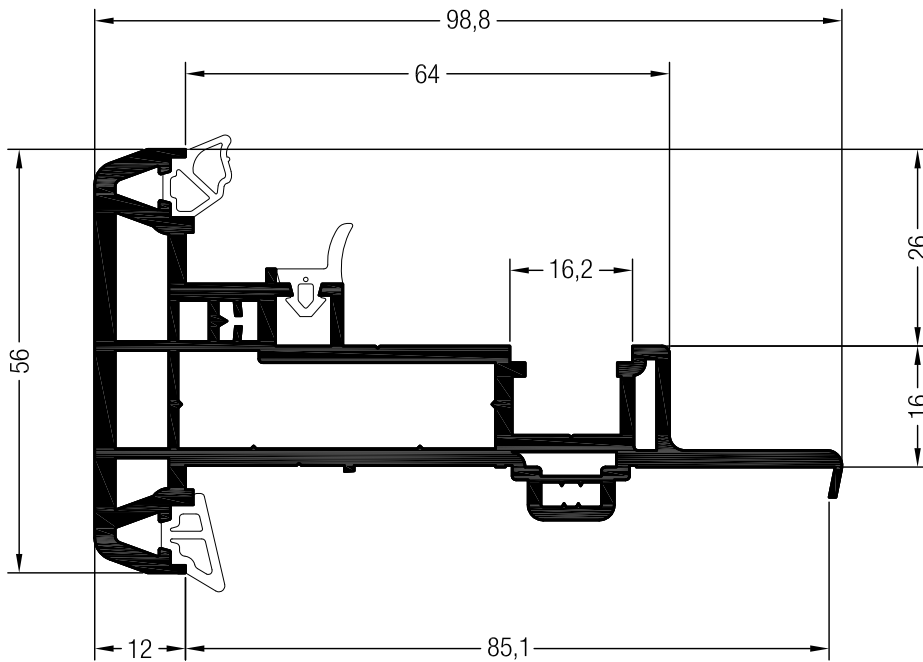

Small dummy mullion profile SYNEGO®

**1537445**

**1567445**

24

Small dummy mullion profile SYNEGO®

for aluminium cover profiles (without universal and and mullion seal)

**1537440**

24

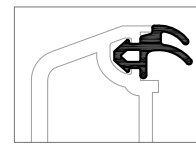

E

	1232881
	1232871

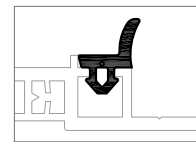

E

	1357443
	1357443

40 x 10

	<b>1247898</b>
	2
lx	2.7
ly	0.25
	6

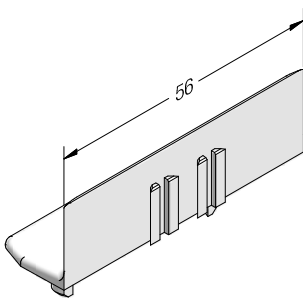
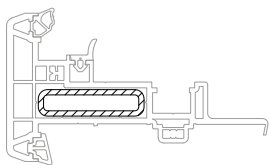

External small dummy mullion profile SYNEGO®

ASA

**1358024**

50

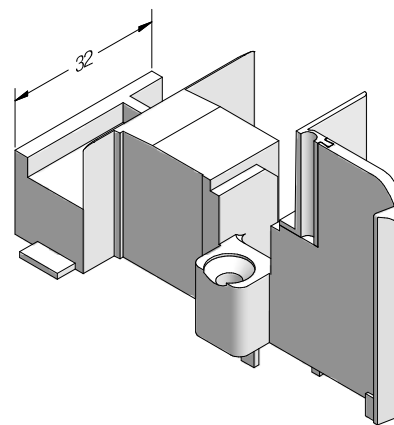

Internal small dummy mullion profile SYNEGO®

ASA/TPE

**1358026**

**1358027**

50

# SYNEGO®

## PROFILE PRINT

### Profiles for multi-sash windows without fixed mullions

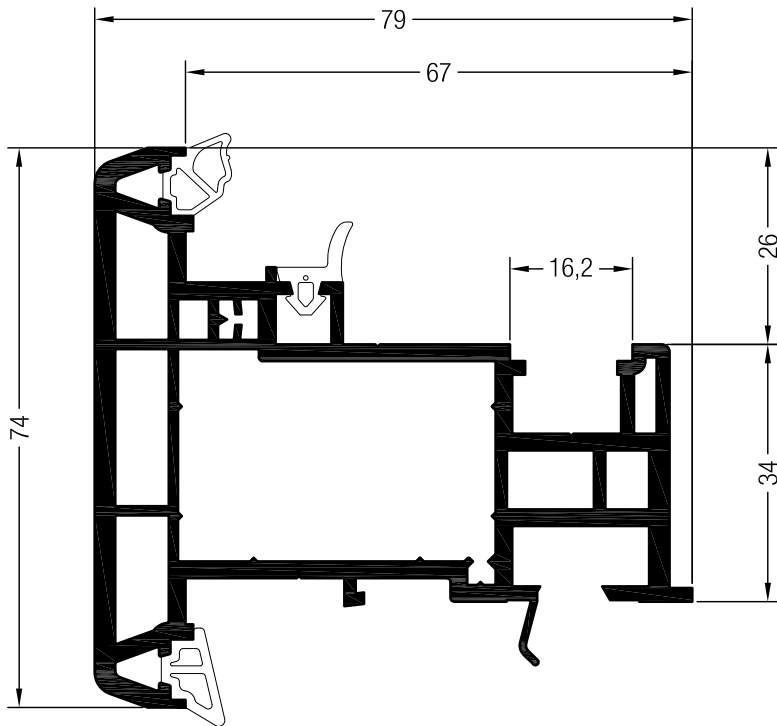

Dummy mullion SYNEGO®

1537455

1567455

24

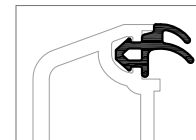

E

	1232881
	1232871

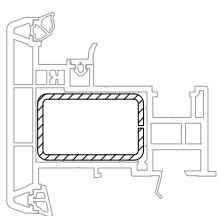

40 x 25

	<b>1357552</b>
	2
lx	4.8
ly	2.3
	6

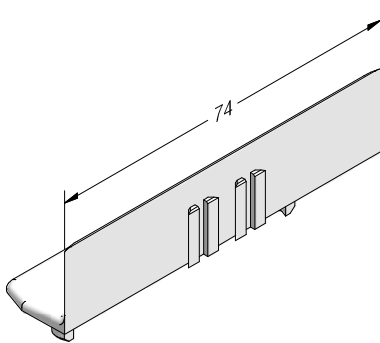

External dummy mullion end cap SYNEGO®

ASA

1358034

50

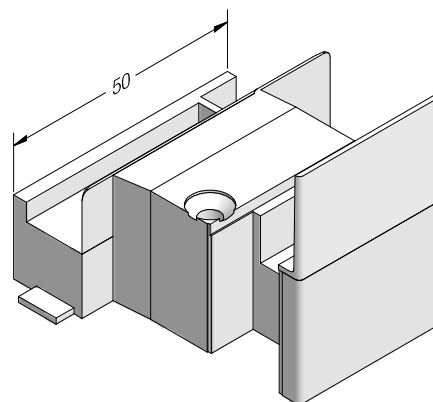

Internal dummy mullion end cap SYNEGO®

ASA/TPE

1358036

1358037

50

# SYNEGO®

## PROFILE PRINT

### Profiles for multi-sash windows without fixed mullions

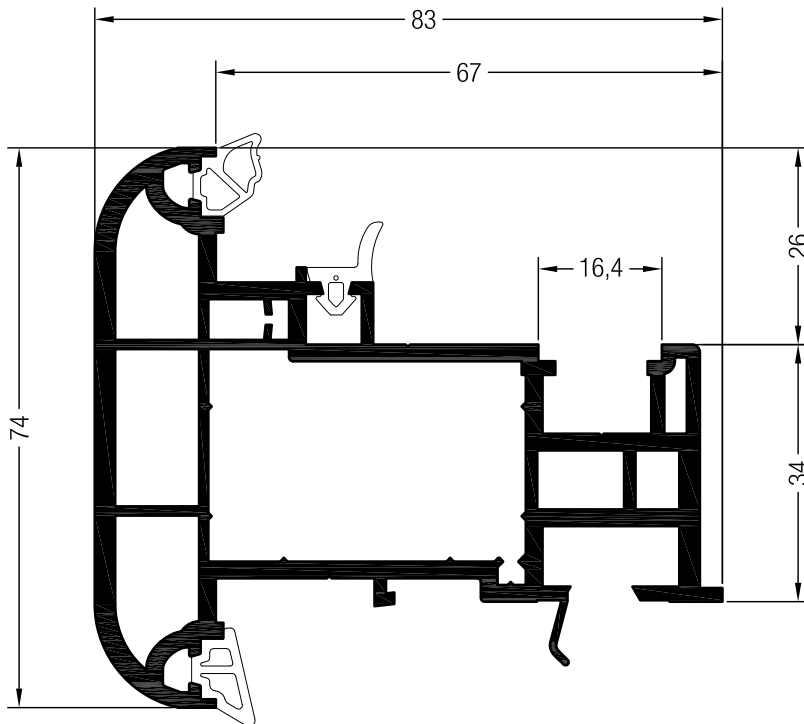

Dummy mullion round SYNEGO®

- 1537465**
- 
- 1567465**
- 24

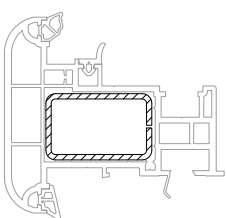

40 x 25

	<b>1357552</b>
	2
lx	4.8
ly	2.3
	6

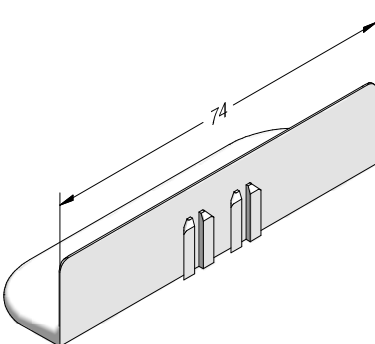

External dummy mullion end cap round SYNEGO®

ASA

- 1358069**

50

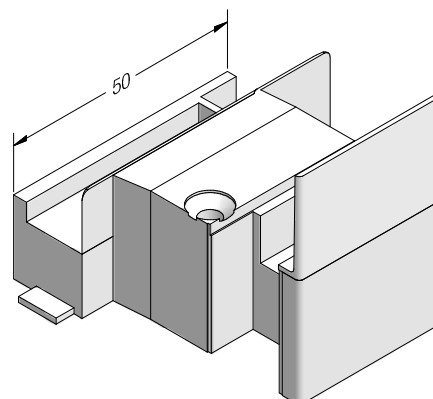

Internal dummy mullion end cap SYNEGO®

ASA/TPE

- 1358036**
- 1358037**

50

# SYNEGO®

## PROFILE PRINT

### Profiles for multi-sash windows without fixed mullions

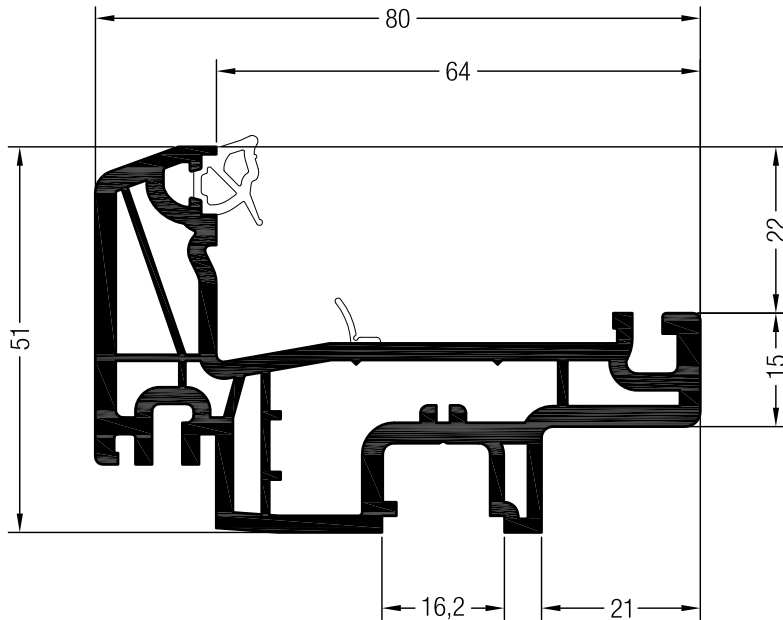

Small dummy mullion sash Z 51 SYNEGO®

1537475

1567475

24

35 x 19

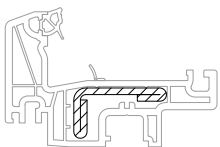

	1351875
	2.5
lx	2.5
ly	0.53
	6

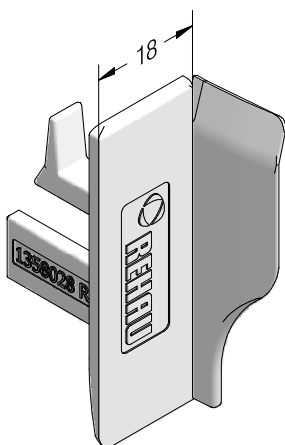

Mullion sash end cap SYNEGO®

TPE

1358028

1358029

50

### Profiles for multi-sash windows without fixed mullion

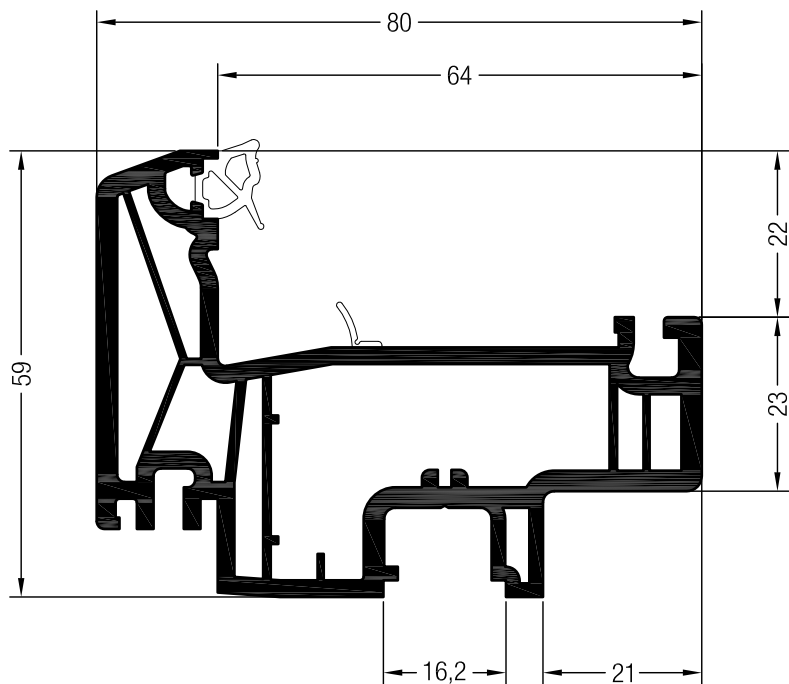

Small dummy mullion sash Z 59 SYNEGO®

1537485

1567485

24

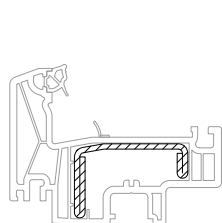

42.8 x 28

	<b>1357554</b>
	2
lx	5.6
ly	1.4
	6

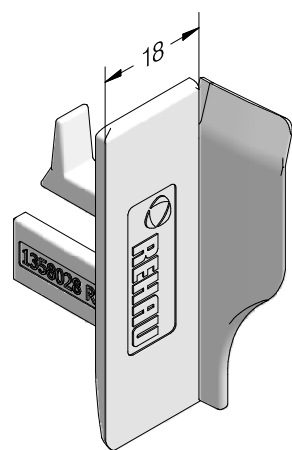

Mullion sash end cap SYNEGO®

TPE

1358028

1358029

50

# SYNEGO®

## PROFILE PRINT

### Profiles for multi-sash windows without fixed mullion

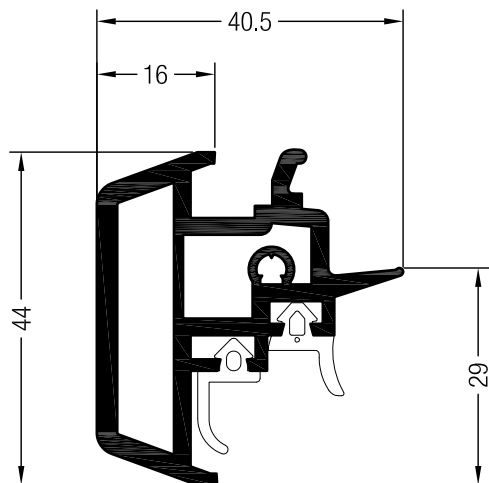

Dummy mullion strip SYNEGO®

1537495 

1567495 

 @

 36

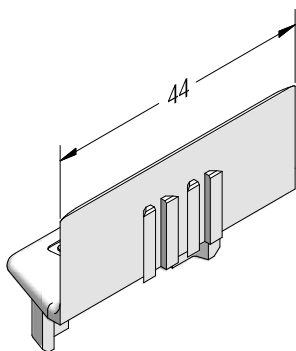

External dummy mullion strip end cap SYNEGO®

ASA

1358110 

 50

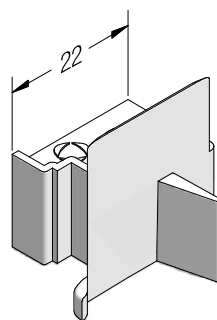

Internal dummy mullion strip end cap SYNEGO®

ASA

1358038 

1358039 



 50

# SYNEGO®

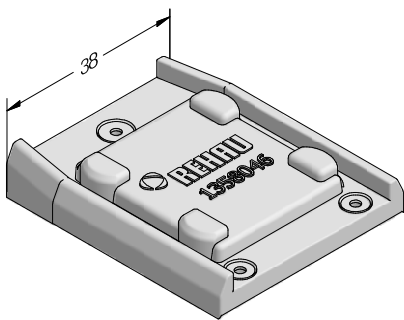

## PROFILE PRINT

### Accessories for mechanical connectors



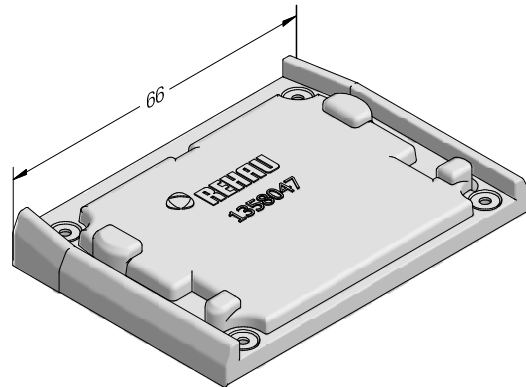

Mechanical mullion connector 96 AD SYNEGO®  
TPE  
**1358046**   
 50

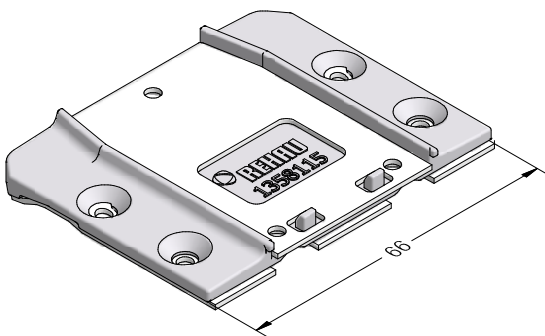

Mechanical mullion connector 124 AD SYNEGO®  
TPE  
**1358047**   
 50



Mechanical mullion connector 96 AD SYNEGO®  
Zinc die casting  
**1358115**   
 50

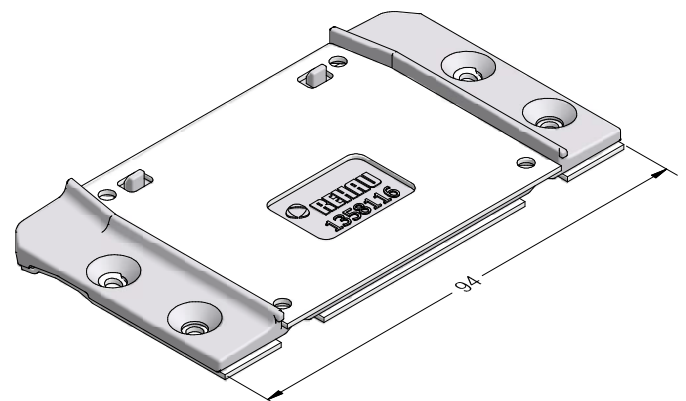

Mechanical mullion connector 124 AD SYNEGO®  
Zinc die casting  
**1358116**   
 50



# SYNEGO®

## PROFILE PRINT

### Accessories for mechanical connectors

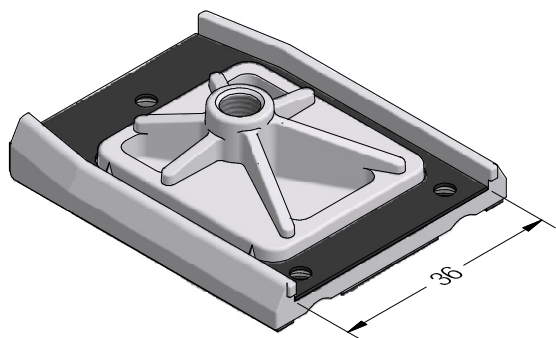

Mechanical mullion connector 96 AD SYNEGO®

Zinc die casting

**1358122** 

 50

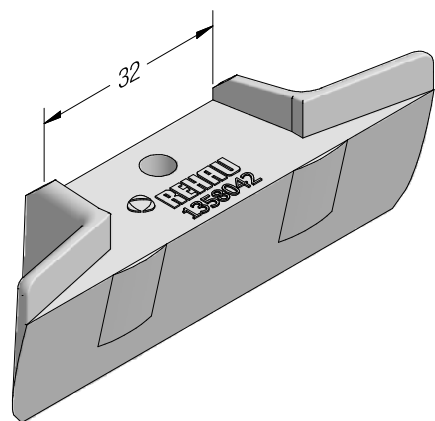

Mullion sealing block 96 MD SYNEGO®

TPE

**1358042**  

 50

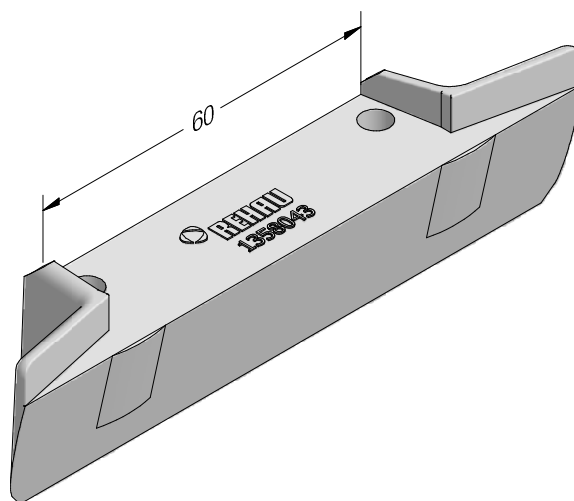

Mullion sealing block 124 MD SYNEGO®

TPE

**1358043**  

 50

### Accessories for mechanical connectors

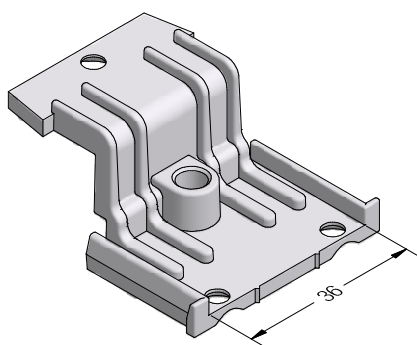

Mechanical mullion connector 96 MD SYNEGO®

Zinc die casting

**1358118** 

 50

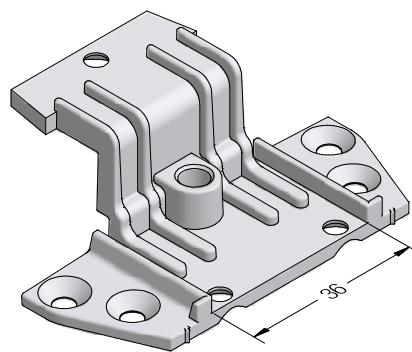

Mechanical mullion connector 96 MD SYNEGO® cross joint

Zinc die casting

**1358119** 

 50

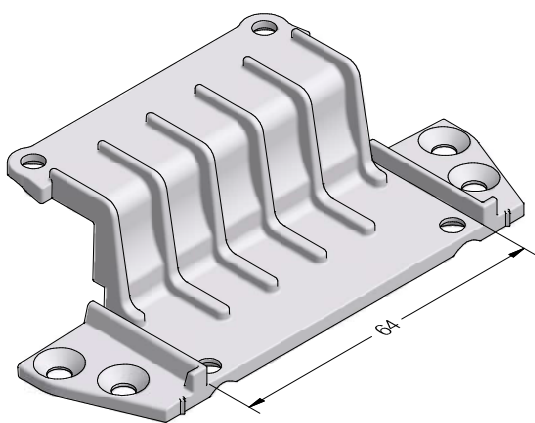

Mechanical connector muntin 124 MD SYNEGO® cross joint

Zinc die casting

**1358128** 

 50

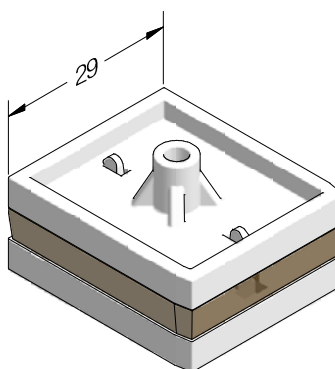

Mullion sealing block 96 MD SYNEGO®

PA/TPE

**1358058** 

 50

# SYNEGO®

## PROFILE PRINT

### Accessories for mechanical connectors

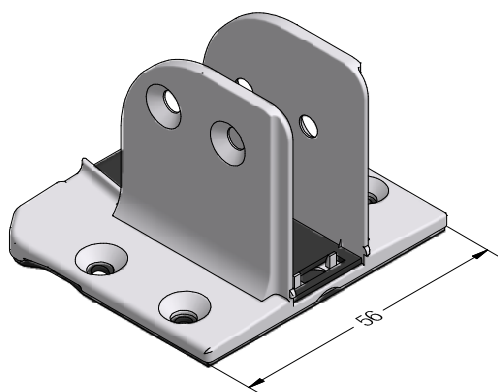

Mechanical connector muntin 68 SYNEGO®

Zinc die casting

**1358044** 

 50

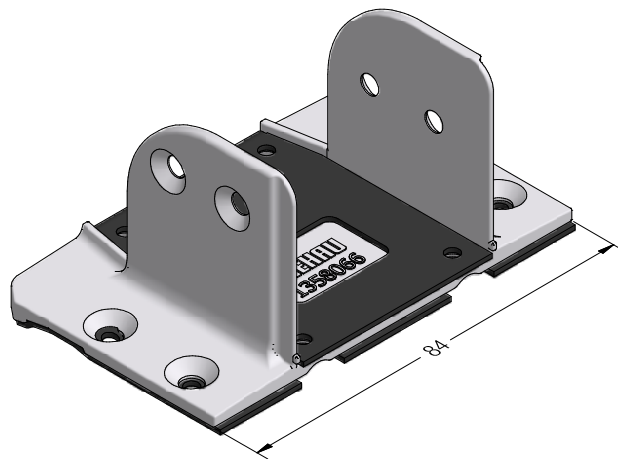

Mechanical connector muntin 96 SYNEGO®

Zinc die casting

**1358066** 

 50

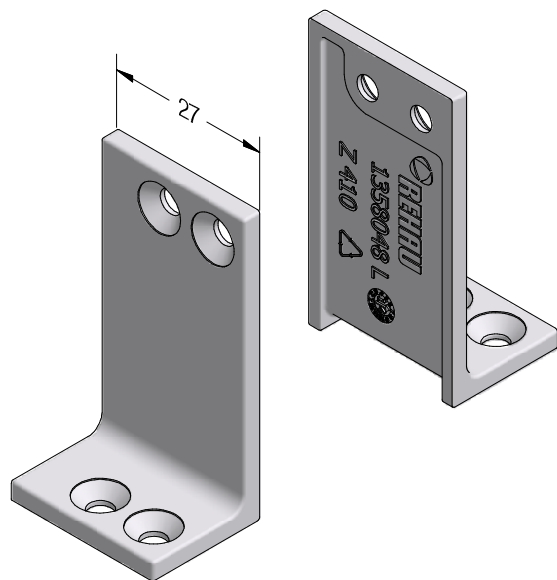

Set mullion brackets mullion cross joint MD SYNEGO®

Zinc die casting

**1358048** 

 20

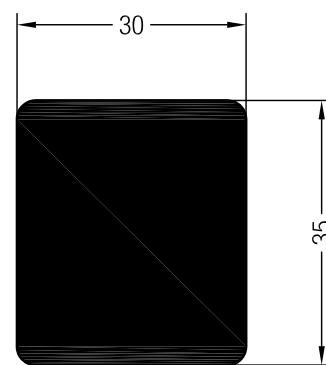

Mechanical connector universal mullion 96 SYNEGO®

30 x 35

**1358033** 

 2

### Accessories for mechanical connectors

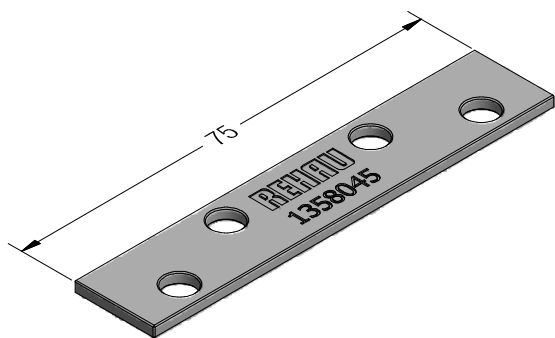

Mullion mounting plate 96 and 124 SYNEGO®

Galvanised steel

**1358045** 

 400

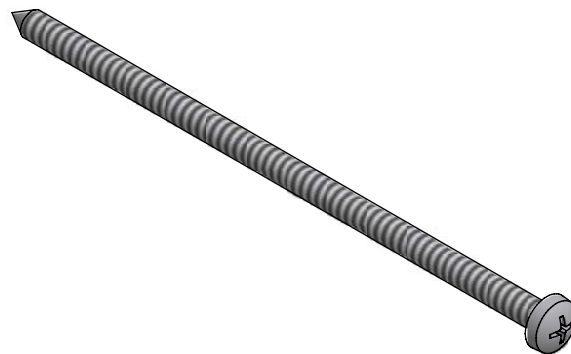

Sheet metal screw ISO 7049, 4,2 x 100

Galvanised steel

**1247725**

 200

Sheet metal screw ISO 7049, 4,2 x 120

Galvanised steel

**1207679**

 100

# SYNEGO®

## PROFILE PRINT

### Threshold and accessories

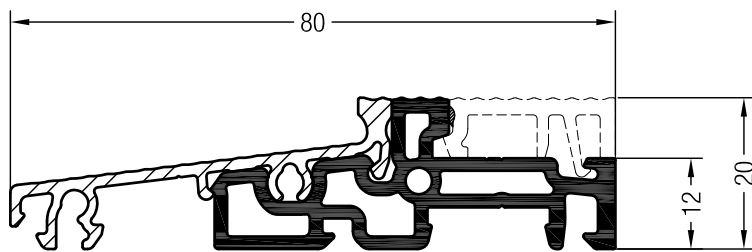
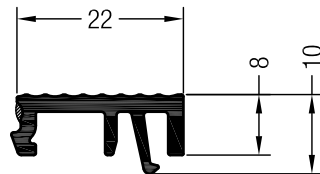

Set threshold installation depth 80

**1356663**

6

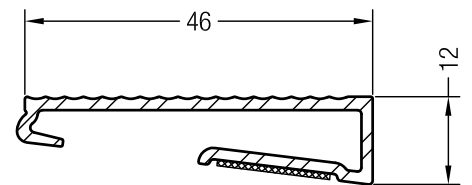

Cover profile, opening outwards, installation depth 80

**1356673**

6

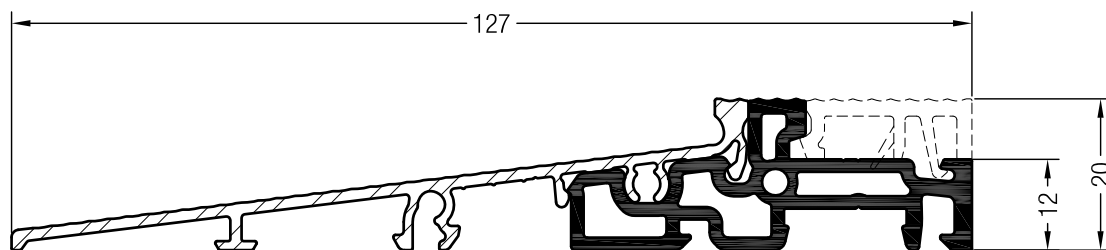
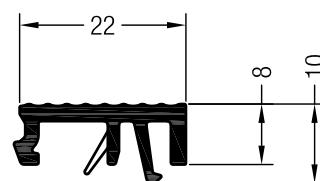

Set threshold installation 127 SYNEGO®

**1358663**

6

# SYNEGO®

## PROFILE PRINT

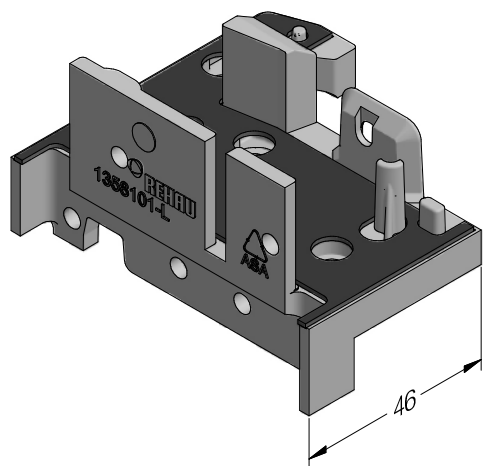

### Threshold and accessories



Frame threshold support 72 SYNEGO®

ASA

1358100  



1358101  

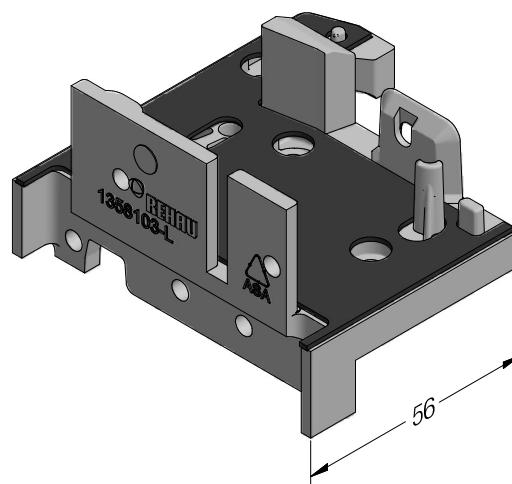

 50



Frame threshold support 82 SYNEGO®

ASA

1358102  

1358103  

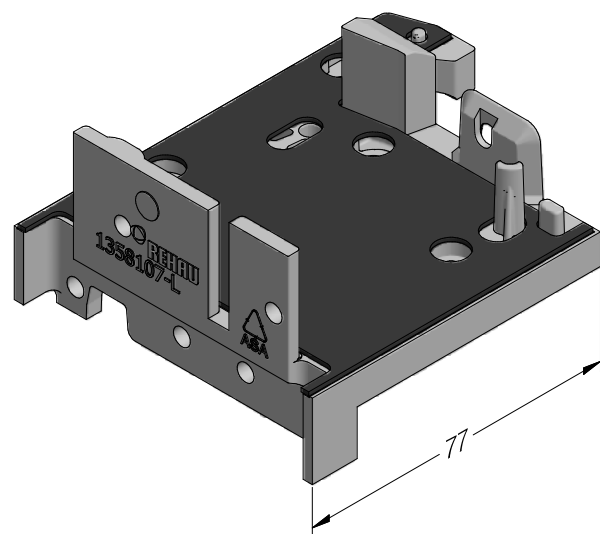

 50



Frame threshold support 103 SYNEGO®

ASA

1358106  

1358107  

 50

# SYNEGO®

## PROFILE PRINT

### Threshold and accessories

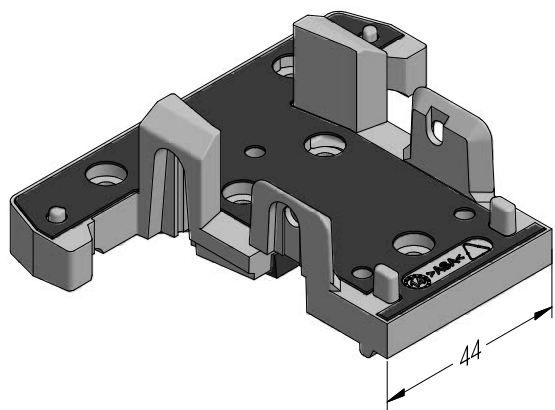

Mullion threshold support 96 SYNEGO®

ASA

**1358104** ■

 50

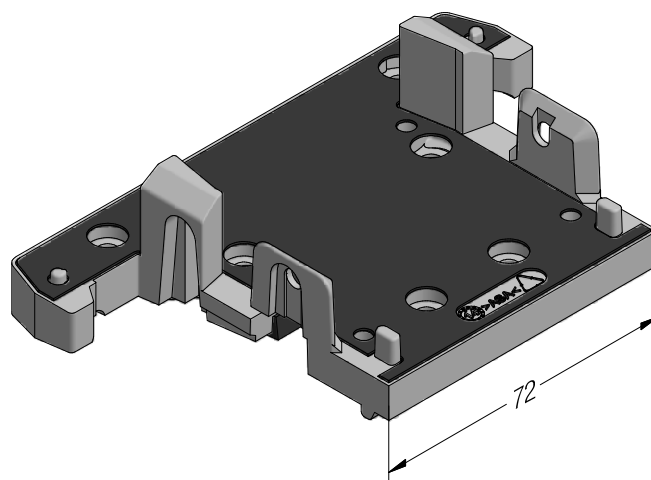

Mullion threshold support 124 SYNEGO®

ASA

**1358105** ■

 50

# SYNEGO®

## PROFILE PRINT

### Threshold and accessories

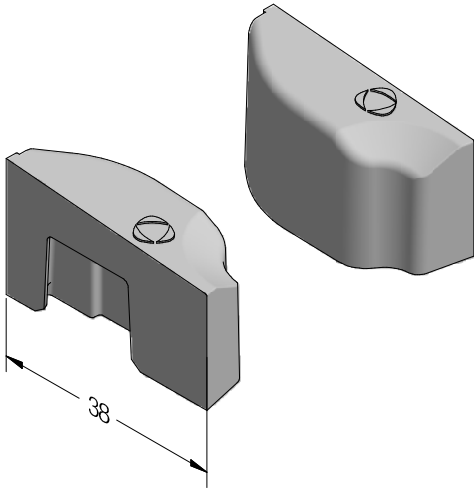

Set wind stop AD SYNEGO®

TPE

**1358108** ■

50

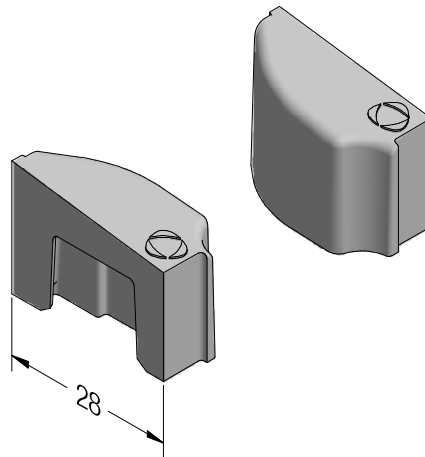

Set wind stop MD SYNEGO®

TPE

**1358109** ■

50

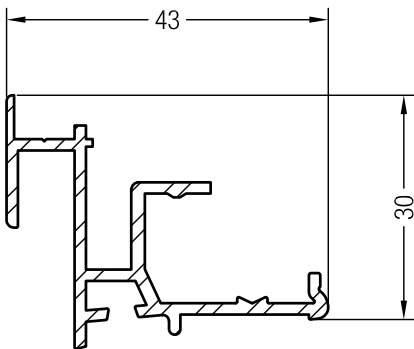

Compensating profile SYNEGO®

**1357344** ▨

6

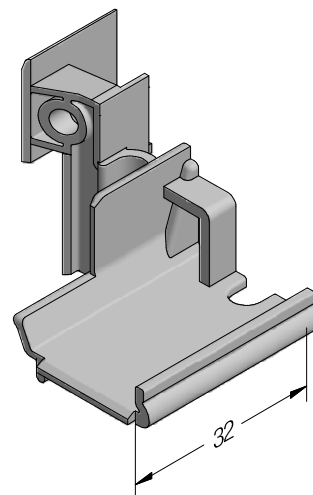

Compensating profile end cap®

ASA

**1358056** ↶ ■

**1358057** ↷ ■

50

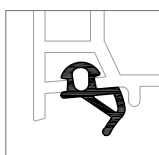

■	<b>1330101</b>
■	<b>1330101</b>
	500



# SYNEGO®

## PROFILE PRINT

### Threshold and accessories

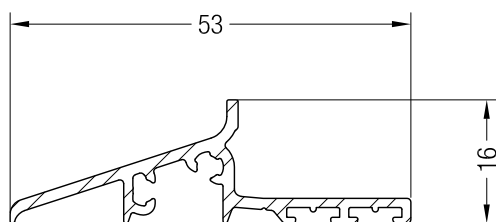



Weather rail SYNEGO®

**1357341** 

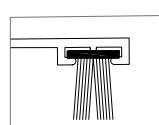
 6



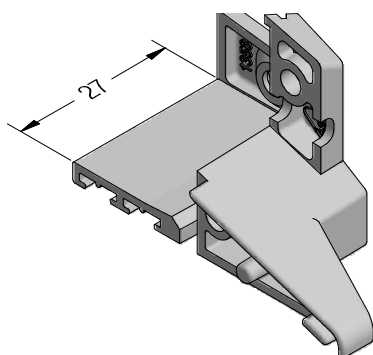

	<b>1248095</b>
	50



Weather rail end cap SYNEGO®

ASA

**1358052**  

**1358053**  

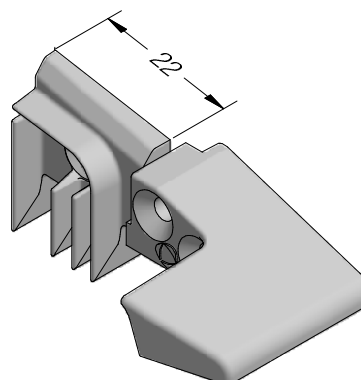

 50



Mullion weather rail end cap SYNEGO®

ASA

**1358054**  

**1358055**  

 50

# SYNEGO®

## PROFILE PRINT

### Threshold and accessories

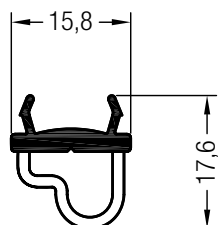

Thermal barrier

**1353383** 

 6

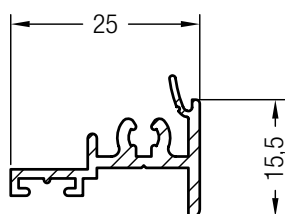



Sash cover profile T SYNEGO®

**1353550** 

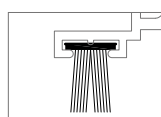
 6



	<b>1248095</b>
	50

### Outward opening element accessories

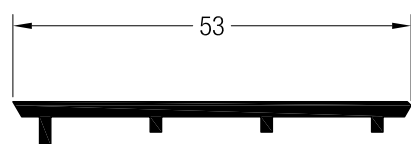

Rebate infill profile SYNEGO®

**1537340** 

 72

### Accessories for glass bonding sash

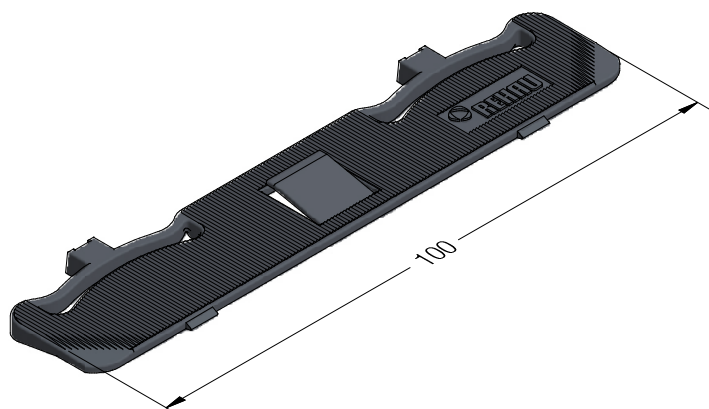

Setting block for glass bonding sash SYNEGO®

**1358157** 

 500

Supply availability as of 05.2018

# SYNEGO®

## PROFILE PRINT

### Accessories for entry and side doors

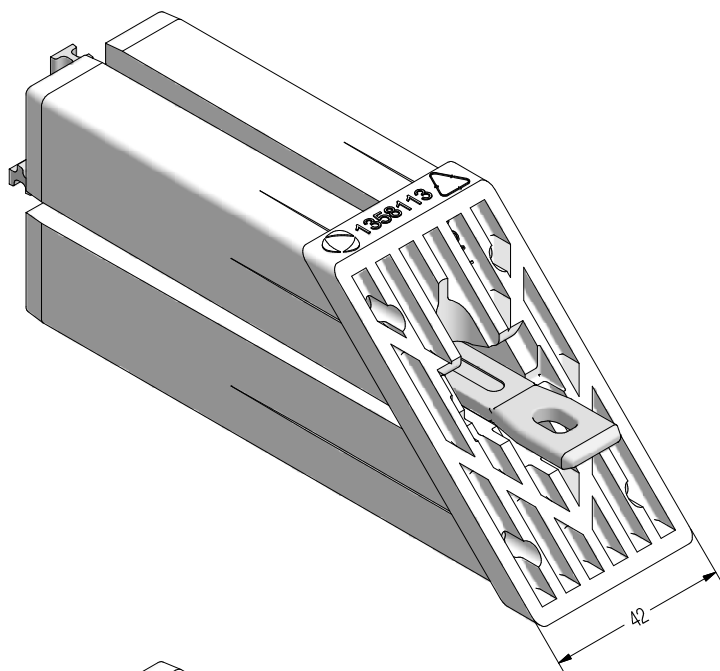

Weldable corner joint front door sash SYNEGO®

PVC-U

**1358113** 

 96

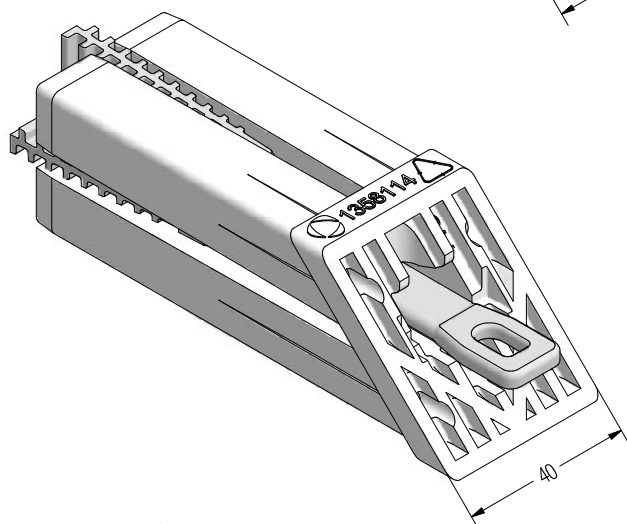

Weldable corner joint door sash 86/106 SYNEGO®

PVC-U

**1358114** 

 96



Clamping lever

Zinc die casting

**1353616** 

 1

# SYNEGO®

## PROFILE PRINT

### Drilling jig

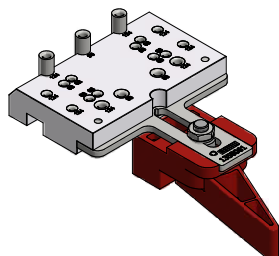

Mech. drilling jig Jig/muntin connector AD SYNEGO®  
(drilling jig for frame SYNEGO® AD,  
drilling jig for mullion SYNEGO® AD in connection with cross joint,  
Drilling jig for sash SYNEGO® in connection with muntin 68 SYNEGO®)

**1358061**



1

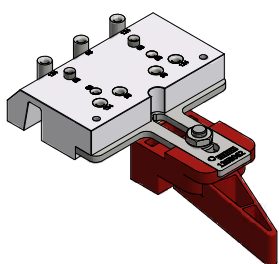

Mech. drilling jig Jig /muntin connector MD SYNEGO®  
(Drilling jig for frame SYNEGO® MD,  
drilling jig for sash SYNEGO® in connection with muntin 68 SYNEGO®)

**1358062**



1

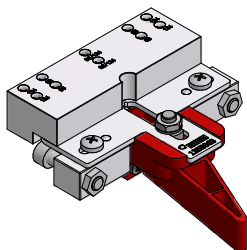

Mech. drilling jig Connector mullion corner SYNEGO®  
(Drilling jig for mullion SYNEGO® MD in connection with cross joint)

**1358063**



1

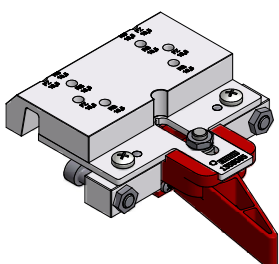

Threshold support drilling template SYNEGO®  
(Drilling jig for frame and mullion SYNEGO® AD/MD)

**1358065**



1

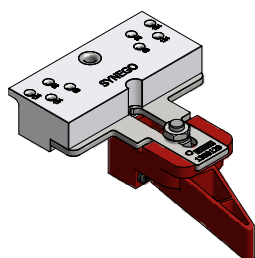

Mech. drilling jig Mullion connector 96/124 MD SYNEGO®  
(Drilling jig for frame and mullion 96/124 SYNEGO® MD)

**1358129**



1

# SYNEGO®

## PROFILE PRINT

### Drilling jig

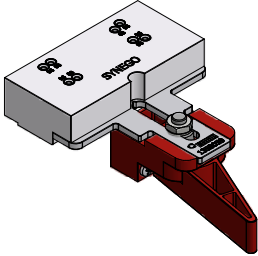

Mech. drilling jig Mullion/muntin connector  
(Drilling jig for sash and muntins 68/96 SYNEGO®)

**1358059**



1

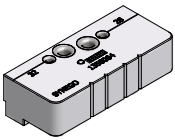

Drilling jig element coupling and mounting SYNEGO®

**1358064**



1

### Reinforcements

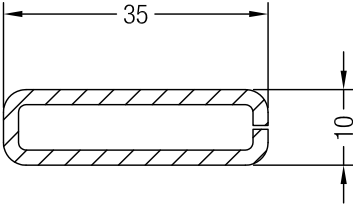
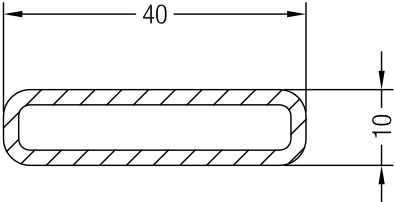
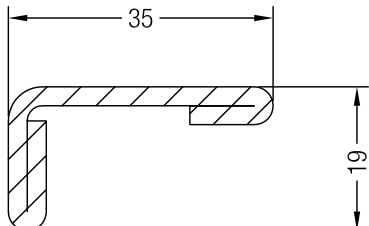
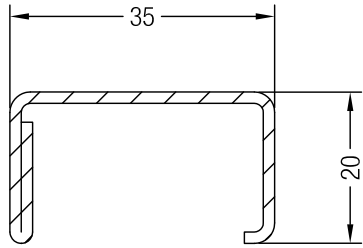
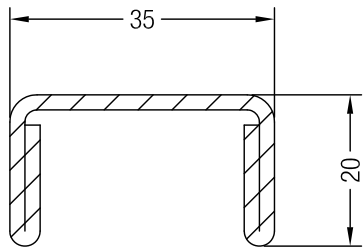
	Art. no.		lx	ly
	<b>1261801</b>	2	1.8	0.22
	<b>1247898</b>	2	2.7	0.25
	<b>1351875</b>	2.5	2.5	0.53
	<b>1261831</b>	1.5	2.5	0.56
	<b>1261841</b>	2	3.1	0.69
	<b>1351893</b>	2	3.8	0.77

### Reinforcements

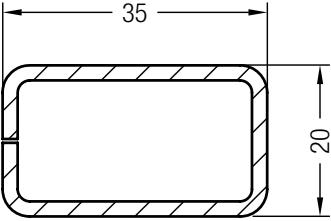
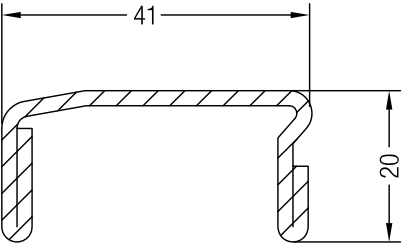
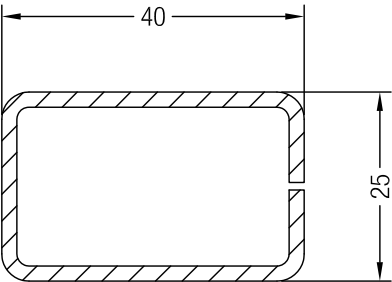
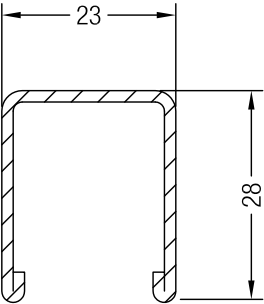
	Art. no.		lx	ly
	<b>1239583</b>	1.5	2.3	0.98
	<b>1357590</b>	2	4.9	0.8
	<b>1357552</b>	2	4.8	2.3
	<b>1306619</b>	1.5	1.1	1.1

# SYNEGO®

## PROFILE PRINT

### Reinforcements

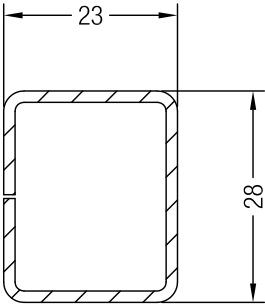
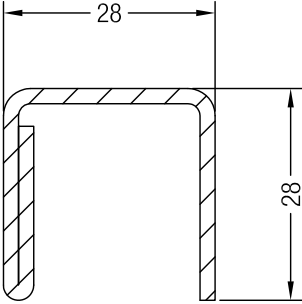
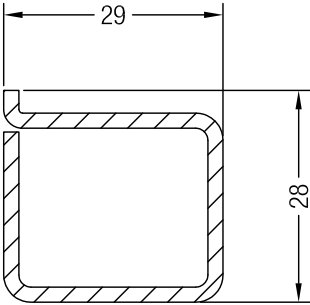
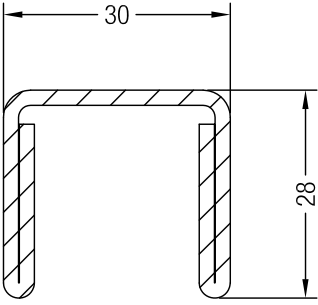
	Art. no.		lx	ly
	<b>1357540</b>	1.5	1.1	1.5
	<b>1357610</b>	1.5	2	1.2
	<b>1313130</b>	2	2.5	1.6
	<b>1357550</b>	2	2.3	1.8
	<b>1306617</b>	2	3.7	1.9



# SYNEGO®

## PROFILE PRINT

### Reinforcements

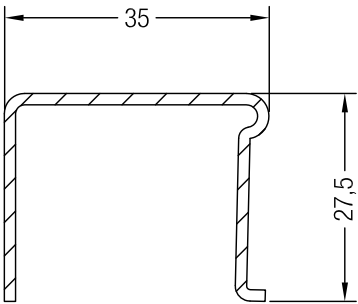
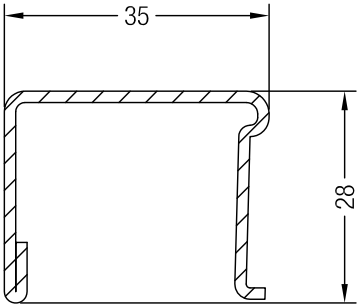
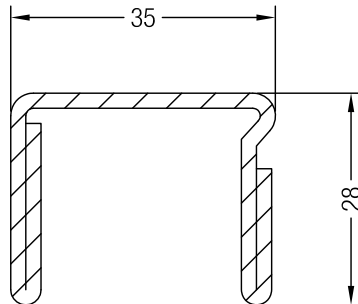
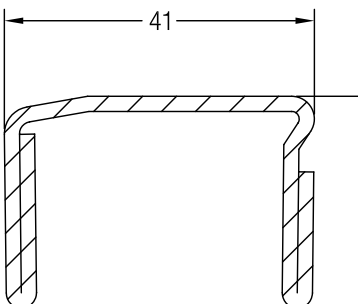
	Art. no.		lx	ly
	<b>1244506</b>	1.5	2.5	1.1
	<b>1244516</b>	1.5	2.7	1.3
	<b>1244526</b>	2	3.5	1.7
	<b>1244536</b>	2	5	2
	<b>1352512</b>	2	7.1	2.1

# SYNEGO®

## PROFILE PRINT

### Reinforcements

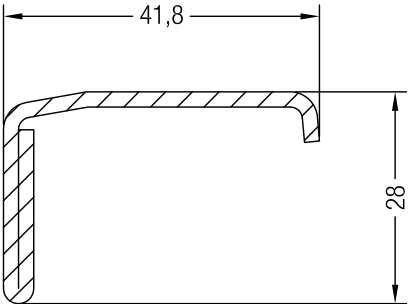
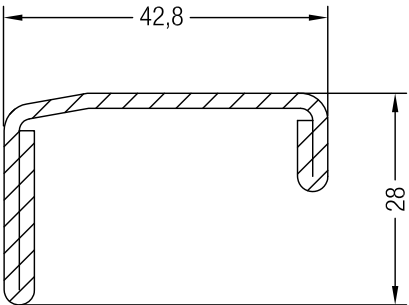
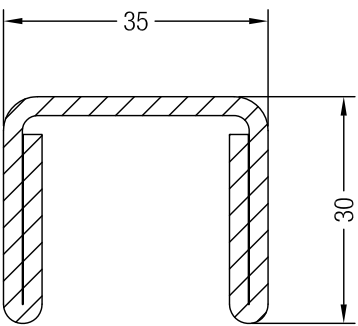
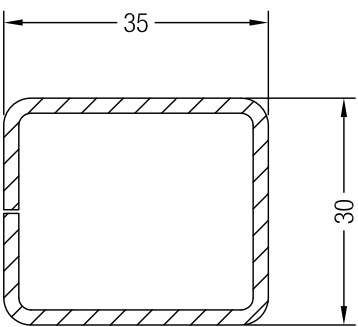
	Art. no.		lx	ly
	<b>1352515</b>	2	3.3	1.4
	<b>1357554</b>	2	5.6	1.4
	<b>1357551</b>	2.5	6.6	2.9
	<b>1357666</b>	1.5	3.2	2.5
	<b>1357544</b>	2	4	3.1

# SYNEGO®

## PROFILE PRINT

### Reinforcements

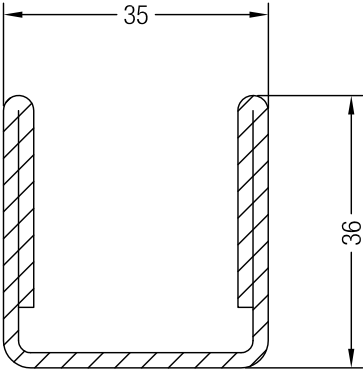
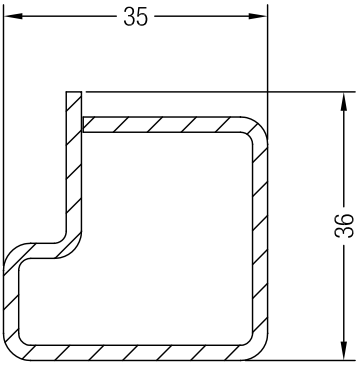
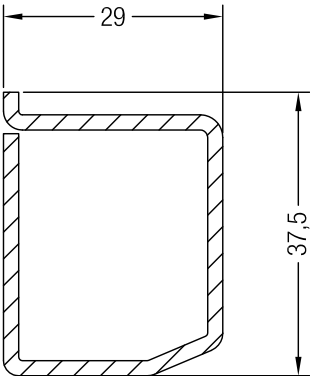
	Art. no.		lx	ly
	<b>1357608</b>	2	6.6	3.9
	<b>1357543</b>	2	3.6	3.7
	<b>1357559</b>	2	2.9	3.9

### Reinforcements

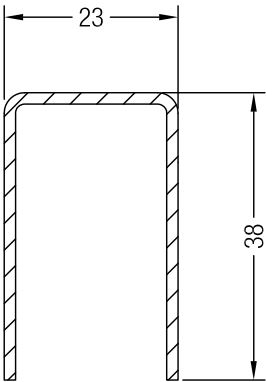
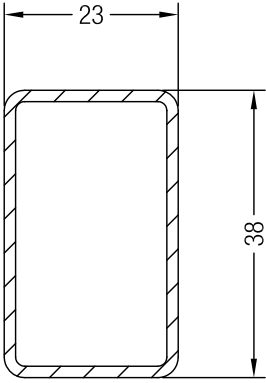
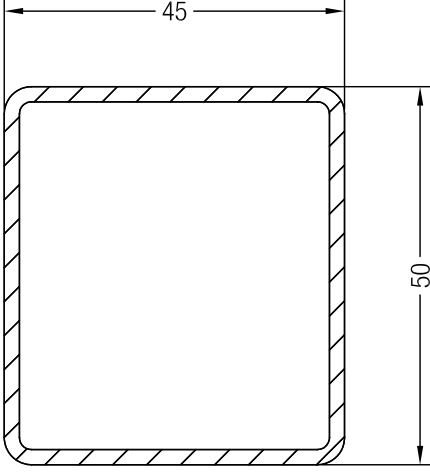
	Art. no.		lx	ly
	<b>1357541</b>	1.5	1.4	2.1
	<b>1357542</b>	1.5	1.5	3.2
	<b>1357545</b>	2	11.1	13.1
	<b>1357553</b>	4	19.3	22.8

**Reinforcements**

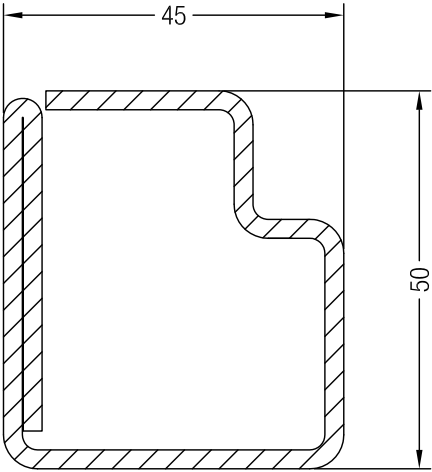
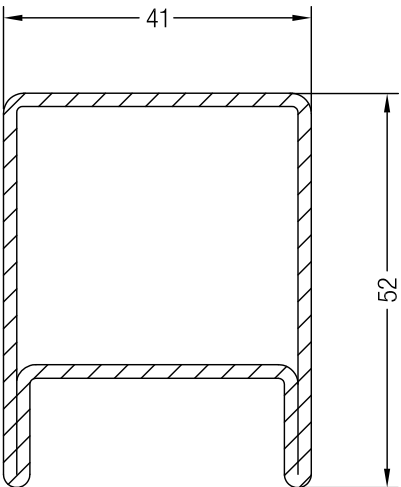
	Art. no.		lx	ly
	<b>1357546</b>	2.5	14.1	15.4
	<b>1357597</b>	1.75	9.7	10.5

# SYNEGO®

## PROFILE PRINT

### Reinforcements

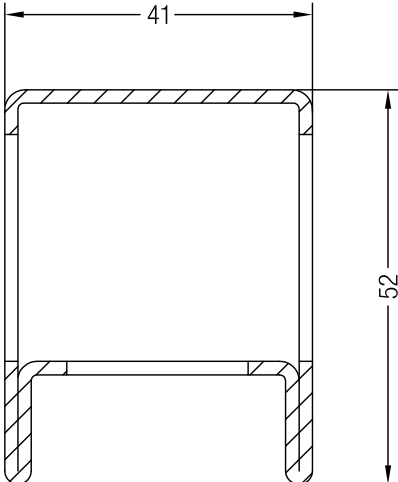
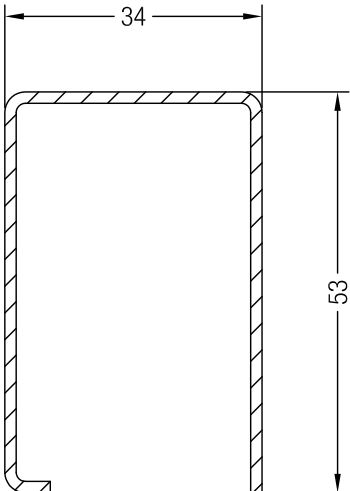
	Art. no.		lx	ly
	<b>1357598</b>	1.75	preassembled for lock side	
	<b>1357547</b>	1.5	4.6	6.5

**Reinforcements**

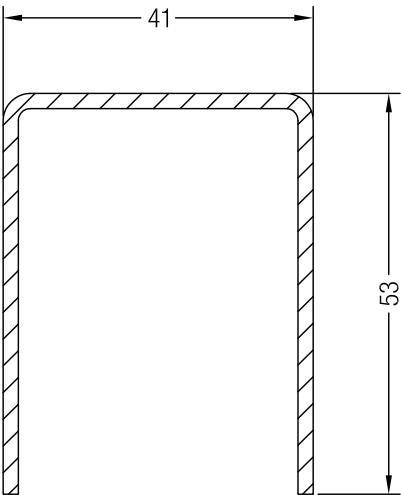
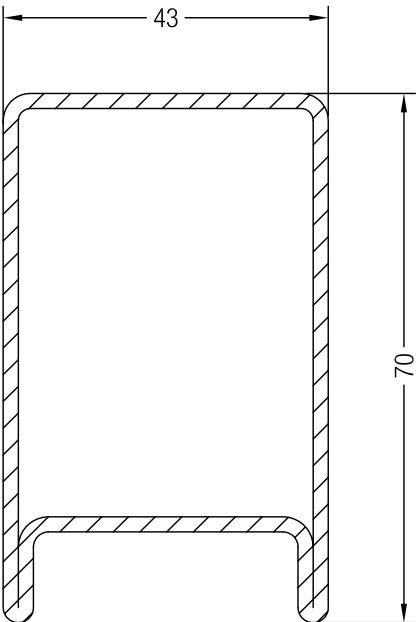
	Art. no.		lx	ly
	<b>1357548</b>	2	8.7	8.4
	<b>1357549</b>	2	14.9	27.1

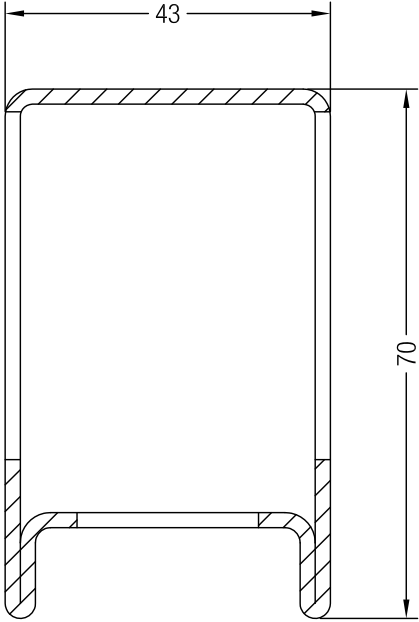
Reinforcements				
	Art. no.		lx	ly
	<b>1357556</b>	2	preassembled for lock side	



# SYNEGO®

## PROFILE PRINT

### Article directory

Art. no.	Designation	Pack/ bundle in m	Metal stillage in m		Carton/ bag in units	Page
			Pack	Shrink-wrapped		
1207679	Screw 4.2 x 120				100	42
1232871	Frame compression seal, black	300				7
1232881	Frame compression seal, grey	300				7
1239583	Reinforcement 35 x 20 x 1.5	6/504				53
1244506	Reinforcement 35 x 28 x 1.5	6/504				55
1244516	Reinforcement 35 x 28 x 1.5	6/432				55
1244526	Reinforcement 35 x 28 x 2	6/432				55
1244536	Reinforcement 35 x 28 x 2	6/312				55
1247725	Screw 4.2 x 100				200	42
1247898	Reinforcement 40 x 10 x 2	6/378				52
1248095	Brush seal 6.7 x 9				50	47
1261801	Reinforcement 35 x 10 x 2	6/480				52
1261831	Reinforcement 35 x 20 x 1.5	6/300				52
1261841	Reinforcement 35 x 20 x 2	6/300				52
1306617	Reinforcement 30 x 28 x 2	6/290				54
1306619	Reinforcement 23 x 28 x 1.5	6/504				53
1313130	Reinforcement 28 x 28 x 2	6/396				54
1351875	Reinforcement 35 x 19 x 2.5	6/378				52
1351893	Reinforcement 35 x 20 x 2	6/324				52
1352512	Reinforcement 41 x 28 x 2	6/288				55
1352515	Reinforcement 41.8 x 28 x 2	6/384				56
1353383	Thermal barrier	6				48
1353550	Sash cover profile T SYNEGO®	6				48
1353616	Clamping lever	1				49
1356663	Set threshold installation depth 80	6				43
1356673	Cover profile, opening outwards, installation depth 80	6				43
1357341	Weather rail SYNEGO®	6				47
1357344	Compensating profile SYNEGO®	6				46
1357540	Reinforcement 23 x 28 x 1.5	6/504				54
1357541	Reinforcement 23 x 38 x 1.5	6/468				58
1357542	Reinforcement 23 x 38 x 1.5	6/480				58
1357543	G reinforcement 35 x 36 x 2	6/240				57
1357544	Reinforcement 35 x 30 x 2	6/300				56
1357545	Reinforcement 45 x 50 x 2	6/192				58
1357546	G reinforcement 45 x 50 x 2.5	6/126				59
1357547	Reinforcement 34 x 53 x 1.5	6/324				60
1357548	Reinforcement 41 x 53 x 2	6/276				61
1357549	Reinforcement 43 x 70 x 2	6/150				61
1357550	Reinforcement 29 x 28 x 2	6/360				54
1357551	Reinforcement 35 x 30 x 2.5	6/216				56
1357552	Reinforcement 40 x 25 x 2	6/312				53

# SYNEGO®

## PROFILE PRINT

### Article directory

Art. no.	Designation	Pack/ bundle in m	Metal stillage in m		Carton/ bag in units	Page
			Pack	Shrink-wrapped		
1357553	Reinforcement 45 x 50 x 4	6/96				58
1357554	Reinforcement 42.8 x 28 x 2	6/336				56
1357556	Reinforcement 43 x 70 x 2, preassembled	2.4				62
1357559	Reinforcement 29 x 37.5 x 2	6/270				57
1357590	Reinforcement 41 x 20 x 2	6/288				53
1357597	Reinforcement 41 x 52 x 1.75	6/192				59
1357598	Reinforcement 41 x 52 x 1,75, preassembled	2.2				60
1357608	Reinforcement 35 x 36 x 2	6/216				57
1357610	Reinforcement 28 x 28 x 1.5	6/396				54
1357666	Reinforcement 35 x 30 x 1.5	6/336				56
1358024	External mullion profile end cap SYNEGO®				50	32
1358026	Internal mullion profile end cap SYNEGO® (right)				50	32
1358027	Internal mullion profile end cap SYNEGO® (left)				50	32
1358028	Mullion sash end cap SYNEGO® (right)				50	36
1358029	Mullion sash end cap SYNEGO® (left)				50	36
1358033	Mechanical connector universal mullion jamb 96 SYNEGO®	2				41
1358034	External dummy mullion end cap SYNEGO®				50	33
1358036	Internal dummy mullion end cap SYNEGO® (right)				50	33
1358037	Internal dummy mullion end cap SYNEGO® (left)				50	33
1358038	Internal mullion bar end cap SYNEGO® (right)				50	37
1358039	Internal mullion bar end cap SYNEGO® (left)				50	37
1358042	Mullion sealing block 96 MD SYNEGO®				50	39
1358043	Mullion sealing block 124 MD SYNEGO®				50	39
1358044	Mechanical connector muntin 68 SYNEGO®				50	41
1358045	Mullion mounting plate 96 and 124 SYNEGO®				400	42
1358046	Mechanical mullion connector 96 AD SYNEGO®				50	38
1358047	Mechanical mullion connector 124 AD SYNEGO®				50	38
1358048	Mullion corner set SYNEGO®				20	41
1358052	Weather rail end cap SYNEGO® (right)				50	47
1358053	Weather rail end cap SYNEGO® (left)				50	47
1358054	Mullion weather rail end cap SYNEGO® (right)				50	47
1358055	Mullion weather rail end cap SYNEGO® (left)				50	47
1358056	Compensating profile end cap SYNEGO® (right)				50	46
1358057	Compensating profile end cap SYNEGO® (left)				50	46
1358058	Mullion sealing block 96 MD SYNEGO®				50	40
1358059	Mech. drilling jig Muntin connector SYNEGO®				1	51
1358061	Mech. drilling jig Mullion/Georgian bar connector AD SYNEGO®				1	50
1358062	Mech. drilling jig Mullion/muntin connector MD SYNEGO®				1	50
1358063	Mech. drilling jig Connector mullion corner SYNEGO®				1	50
1358064	Drilling jig element coupling SYNEGO®				1	51
1358065	Threshold support drilling template SYNEGO®				1	50

# SYNEGO®

## PROFILE PRINT

### Article directory

Art. no.	Designation	Pack/ bundle in m	Metal stillage in m		Carton/ bag in units	Page
			Pack	Shrink-wrapped		
1358066	Mechanical connector muntin 96 SYNEGO®				50	41
1358069	External dummy mullion end cap round SYNEGO®				50	34
1358100	Frame threshold support 72 SYNEGO® (right)				50	44
1358101	Frame threshold support 72 SYNEGO® (left)				50	44
1358102	Frame threshold support 82 SYNEGO® (right)				50	44
1358103	Frame threshold support 82 SYNEGO® (left)				50	44
1358104	Mullion threshold support 96 SYNEGO®				50	45
1358105	Mullion threshold support 124 SYNEGO®				50	45
1358106	Frame threshold support 103 SYNEGO® (right)				50	44
1358107	Frame threshold support 103 SYNEGO® (left)				50	44
1358108	Set wind stop AD SYNEGO®				50	46
1358109	Set wind stop MD SYNEGO®				50	46
1358110	External dummy mullion strip end cap SYNEGO®				50	37
1358113	Weldable corner connection entry door sash SYNEGO®				96	49
1358114	Weldable corner connection HT sash 86/106 SYNEGO®				96	49
1358115	Mechanical mullion connector 96 AD SYNEGO®				50	38
1358116	Mechanical mullion connector 124 AD SYNEGO®				50	38
1358118	Mechanical mullion connector 96 MD SYNEGO®				50	40
1358119	Mechanical mullion connector 96 MD SYNEGO® cross connection				50	40
1358122	Mechanical mullion connector 96 AD SYNEGO®				50	39
1358128	Mechanical mullion connector 124 MD SYNEGO®				50	40
1358129	Mech. drilling jig Mullion connector 96/124 MD SYNEGO®				1	50
1358157	Setting block for glass bonding sash SYNEGO®				500	48
1358663	Set threshold installation 127 SYNEGO®				6	43
1537005	Frame 72 AD PULS SYNEGO®	24	360	462		2
1537008	Frame 72 AD PULS SYNEGO® for aluminium cover profiles	24	360			2
1537015	Frame 82 AD PULS SYNEGO®	24	288	378		4
1537018	Frame 82 AD PULS SYNEGO® for aluminium cover profiles	24	288			4
1537100	Frame 72 MD SYNEGO® (without universal seal)	24	360			8
1537115	Frame 82 MD PULS SYNEGO®	24	288	378		10
1537118	Frame 82 MD PULS SYNEGO® for aluminium cover profiles	24	288			10
1537135	Frame 103 MD PULS SYNEGO®	12	216	216		12
1537145	Renovation frame 57/60 MD SYNEGO®	24	432			13
1537165	Frame 72/40 MD PULS SYNEGO®	24	360	324		14
1537175	Frame 72 MD PULS SYNEGO®	24	360	462		8
1537178	Frame 72 MD PULS SYNEGO® for aluminium cover profiles	24	360			8
1537185	Frame 100 MD SYNEGO®	24	216	294		16
1537195	Frame 72/40 MD PULS SYNEGO®	24	360	324		15
1537205	Sash Z 51 SYNEGO®	24	432	462		21
1537215	Sash Z 59 SYNEGO®	24	360	462		23
1537225	Sash Z 59 PULS SYNEGO®	24	360	462		23

# SYNEGO®

## PROFILE PRINT

### Article directory

Art. no.	Designation	Pack/ bundle in m	Metal stillage in m		Carton/ bag in units	Page
			Pack	Shrink-wrapped		
1537235	Sash Z 86 SYNEGO®	24	216	294		26
1537245	Sash 59 round PULS SYNEGO®	24	360	396		25
1537285	Glass bonding sash 53 PULS SYNEGO®	24	360	396		22
1537295	Entry door sash Z SYNEGO®	13	273	273		28
1537305	Entry door sash T SYNEGO®	13	273	273		29
1537315	Sash T 106 SYNEGO®	12	252	294		27
1537325	Compensating profile 95 SYNEGO®	12	216			20
1537335	Compensating profile 48 SYNEGO®	24	360			19
1537340	Rebate infill profile SYNEGO®	72				48
1537405	Mullion 96 AD PULS SYNEGO®	24	288	378		6
1537408	Mullion 96 AD PULS SYNEGO® for aluminium cover profiles	24	288			6
1537415	Mullion 124 AD SYNEGO®	12	252	252		7
1537425	Muntin 68 SYNEGO®	36	432	588		30
1537435	Georgian bar 96 SYNEGO®	24	288			31
1537445	Small dummy mullion profile SYNEGO® (without universal and mullion seal)	24	600			32
1537445	Small dummy mullion profile SYNEGO®	24	600			32
1537455	Dummy mullion SYNEGO®	24	360			33
1537465	Dummy mullion round SYNEGO®	24	360			34
1537475	Small dummy mullion sash Z 51 SYNEGO®	24	576			35
1537485	Small dummy mullion sash Z 59 SYNEGO®	24	504			36
1537495	Dummy mullion strip SYNEGO®	36	1404			37
1537505	Mullion 96 MD PULS SYNEGO®	24	288	378		17
1537508	Mullion 96 MD PULS SYNEGO® for aluminium cover profiles	24	288			17
1537515	Mullion 124 MD SYNEGO®	12	252	252		18
1537525	Sash Z 59 PULS SYNEGO®	24	360	462		24
1537555	Sash Z 59 PULS SYNEGO®	24	360	462		24
1537605	Frame 72 AD PULS SYNEGO®	24	360	462		3
1537608	Frame 72 AD PULS SYNEGO® for aluminium cover profiles	24	360			3
1537615	Frame 82 AD PULS SYNEGO®	24	288	378		5
1537618	Frame 82 AD PULS SYNEGO® for aluminium cover profiles	24	288			5
1537625	Frame 72 MD PULS SYNEGO®	24	360	462		9
1537628	Frame 72 MD PULS SYNEGO® for aluminium cover profiles	24	360			9
1537635	Frame 82 MD PULS SYNEGO®	24	288	378		11
1537638	Frame 82 MD PULS SYNEGO® for aluminium cover profiles	24	288			11
1567005	Frame 72 AD PULS SYNEGO® (laminated)	24	360			2
1567015	Frame 82 AD PULS SYNEGO® (laminated)	24	288			4
1567105	Frame 72 MD SYNEGO® (laminated)	24	360			8
1567115	Frame 82 MD PULS SYNEGO® (laminated)	24	288			10
1567135	Frame 103 MD PULS SYNEGO® (laminated)	12	216			12
1567145@	Renovation frame 57/60 MD SYNEGO® (laminated)	24	432			13
1567165@	Frame 72/40 MD PULS SYNEGO® (laminated)	24	360			14































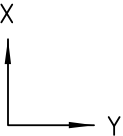

# SYNEGO®

## PROFILE PRINT

### Article directory

Art. no.	Designation	Pack/ bundle in m	Metal stillage in m		Carton/ bag in units	Page
			Pack	Shrink-wrapped		
1567185@	Frame 100 MD SYNEGO® (laminated)	24	216			16
1567195@	Frame 72/40 MD PULS SYNEGO® (laminated)	24	360			15
1567205	Sash Z 51 SYNEGO® (laminated)	24	432			21
1567215	Sash Z 59 SYNEGO® (laminated)	24	360			22
1567235	Sash Z 86 SYNEGO® (laminated)	24	216			26
1567245	Sash 59 round PULS SYNEGO® (laminated)	24	273			25
1567285	Glass bonding sash 53 PULS SYNEGO® (laminated)	24	273			22
1567295	Front door sash Z SYNEGO® (laminated)	13	234			28
1567305	Front door sash T SYNEGO® (laminated)	13	273			29
1567315	Sash T 106 SYNEGO® (laminated)	12	252			27
1567325@	Compensating profile 95 SYNEGO® (laminated)	12	216			20
1567335	Compensating profile 48 SYNEGO® (laminated)	24	360			19
1567405	Mullion 96 AD PULS SYNEGO® (laminated)	24	288			6
1567415	Mullion 124 AD SYNEGO® (laminated)	12	252			7
1567425	Georgian bar 68 SYNEGO® (laminated)	36	432			30
1567435	Muntin 96 SYNEGO® (laminated)	24	288			31
1567445	Small dummy mullion profile SYNEGO® (laminated)	24	600			32
1567455	Dummy mullion SYNEGO® (laminated)	24	360			33
1567465	Dummy mullion round SYNEGO® (laminated)	24	360			34
1567475	Mullion sash Z 51 SYNEGO® (laminated)	24	432			35
1567485	Mullion sash Z 59 SYNEGO® (laminated)	24	504			36
1567495	Small dummy mullion strip SYNEGO® (laminated)	36	1404			37
1567505	Mullion 96 MD PULS SYNEGO® (laminated)	24	288			17
1567515	Mullion 124 MD SYNEGO® (laminated)	12	252			18
1567525	Sash Z 59 PULS SYNEGO® (laminated)	24	360			24
1567605	Frame 72 AD PULS SYNEGO® (laminated)	24	360			3
1567615	Frame 82 AD PULS SYNEGO® (laminated)	24	288			5
1567625	Frame 72 MD PULS SYNEGO® (laminated)	24	360			9
1567635	Frame 82 MD PULS SYNEGO® (laminated)	24	288			11

## Legend

	Colour: black	
	Colour: grey	
	Colour: white	
	Colour: cream	
	Colour: brown	
	Colour: caramel	
	Colour: green	
	Colour: red	
	Colour: silver	
	Colour: any	
	Aluminium, natural anodisation	
	Aluminium mill-finish	
	Laminated version	
	Painted version	
	Packaging unit (for details see list of articles)	
	Wall thickness in mm	
	With weldable seal	
	With non-weldable seal	
	Seal to be inserted manually	
	Right-hand version	
	Left-hand version	
@	Non-standard, delivery time on request	
$I_x$	Moment of inertia in X direction in $\text{cm}^4$	
$I_y$	Moment of inertia in Y direction in $\text{cm}^4$	
	Affix with PVC adhesive, white profiles with adhesive 251660/251670, laminated profiles with solvent-free adhesive (e.g. Cosmofen 515, Weiss).	
	Seal with silicone	
	Seal with EPDM sealant	
	Affix with EPDM adhesive	
	Panhead sheet metal screw ISO 7049	
	Countersunk sheet metal screw ISO 7050	
	Countersunk drilling screw ISO 15482	
	Panhead drilling screw ISO 15481	
	Drilling and cutting jigs	
	Milling contour	
	Aluminium shell	

### Variant system

#### White profiles:

After the article number (e.g. 1537005) variant 4 digit variant follows (e.g. 1701) that has the same pattern as main and supplementary profiles.

The variant consists of 4 digits:

1st and 2nd digits: packaging type

3rd and 4th digits: colour number

1st and 2nd digits	Packaging type
17	Plastic tube stillage (LPG)
19	Shrink wrapped stillage (LPG)

3rd and 4th digits	Colour number	
	Profile	Profile/seal
01	White 159	White/black 159/601
05	White 159	White/white 159/159
15	-	White/grey 159/RAL 7001

Examples:

XXXXXXX 

 36

- Articles in white without seal  
smallest packaging unit 36 m  
Variant 1701: plastic tube stillage  
Variant 1901: shrink wrapping stillage

XXXXXXX

 24

- Articles in white with white seal  
smallest packaging unit 24 m  
Variant 1705: plastic tube stillage  
Variant 1905: shrink wrapping stillage

XXXXXXX

 36

- Articles in white with grey seal  
smallest packaging unit 36 m  
Variant 1715: plastic tube stillage  
Variant 1915: shrink wrapping stillage

#### Laminated profiles:

For laminated profiles, depending on the colour combination desired, a 4-digit colour variant can be found in the standard colour tableau. Laminated profiles are generally delivered in the plastic tube stillage packaging type.

Examples:

XXXXXXX

  

 24

- Articles laminated with black seal  
minimum packaging unit 24 m  
packaging generally in plastic tube stillage  
Colour variant with standard colour palette

### Material number

The 7-digit article number (e.g. 1537005) is summarised with the 4-digit variant (e.g. 1701) to form an 11-digit material number (e.g. 15370051701).

 Not all profiles are available in all the variants listed above.

---

The dimensions given in this document are approximate values. Tolerances are subject exclusively to our conditions of sale. We therefore recommend checking that the details given in this document are suitable for your intended technical solution.

Application, use and processing of our products are beyond our control and are therefore exclusively your responsibility.

Our warranty in any case assumes consistent quality of our products in accordance with our specifications. Should the issue of liability arise, this shall be ba-

sed on our conditions of sale, which are known to you. These conditions of sale can also be found at <http://rehau.de/lzb> or can be forwarded on request. Damage arising from the use of accessories other than original system accessories listed in our documentation is excluded from all warranties and REHAU liability.